



jaga



Eyecatchers

PANEL PLUS HORIZONTAL

€ 2016-2017.EX



Eyecatchers
* From design to art *

PANEL PLUS HORIZONTAL

Elegant simplicity and power

Streamlined, elegant design. The compact style of the Panel Plus allows creative freedom to the designer and saves space too! The Panel Plus can be fitted as a wall mounted radiator, but Jaga also offers a super compact, solid skirting model starting at a height of 6 cm! The robust design of the Panel Plus radiator with its hidden collectors provides an elegant simplicity that oozes quality.

Vertical version: see p. 250.
Freestanding version: see p. 200.

PANEL PLUS HORIZONTAL sandblast grey 001

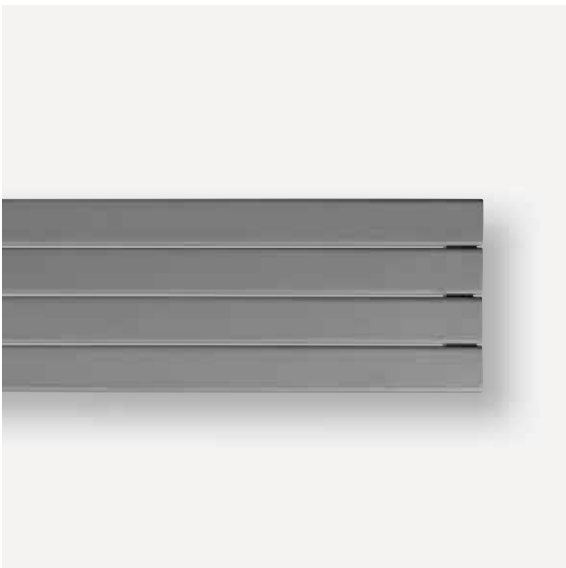



PANEL PLUS HORIZONTAL



PANEL PLUS HORIZONTAL

DIMENSIONS (in cm)

- standard connection
- variant

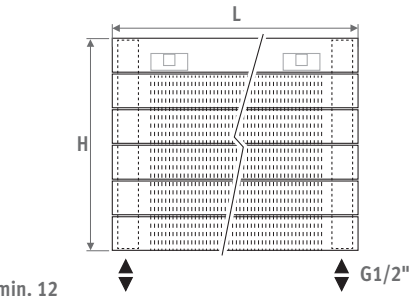
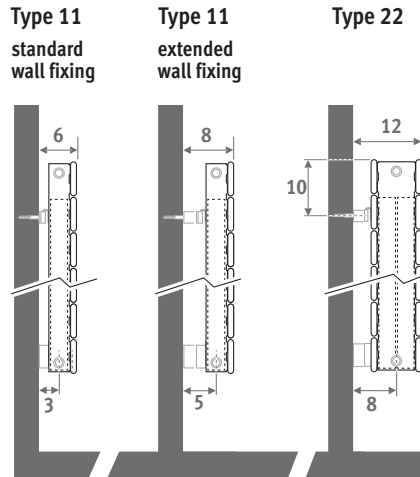
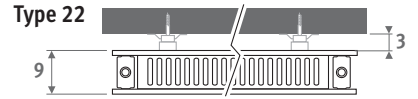
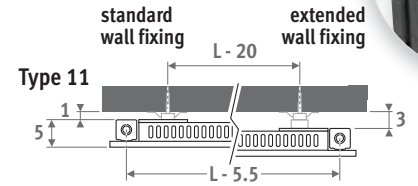

Vertical version: see p. 250.
Freestanding version: see p. 200.

DELIVERY

- connection 18 underneath
- wall fixing
- chrome-plated air vent and drain plug G1/2"
- pre-mounted grille
- type 11 is provided with standard and extended wall fixings

COLOURS

Environmentally friendly, scratch-resistant, high UV resistant powder coating.

Standard colours:

- traffic white RAL 9016 (333), smooth satin matt
- sandblast grey (001), fine texture metallic

Other colours: see colour chart.

CONNECTION

Code:

1° number = flow

2° number = return

Standard connection:

Code 18, reversible 18 or 81

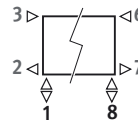

Other connections (no surcharge):

- side connection:
 - one-sided: code 32 or 67 instead of 18
 - cross-over: code 37 or 62 instead of 18
- single point connection: code 11 (left) or 88 (right) instead of 18.

Always use a vertical diffusion tube (ø 10 to 12mm) min. 100 mm long and a reduction washer.

CONNECTION SETS

Example showing connection set to the wall

Jaga Deco double angled

TRV head and sleeve couplings included.



set 35	To the wall	€
	CODE.JH2.DC.1...	158,70

fill in sleeve coupling code	
Precision metal tube 15/1	115
Precision metal tube 16/1	116
Precision metal tube 18/1	118
RPE/ALU tube 16/2	316
RPE/ALU tube 18/2	318

Other connection sets and sleeve couplings

see chapter "Connection sets and valves" for all connection options and technical information

PANEL PLUS HORIZONTAL



	Type	Watts 75/65	Watts 55/45	£ st. colour	£ other
L H 056					
060	11	510	270	472,20	566,70
	22	892	448	934,30	1121,00
080	11	680	359	542,20	650,70
	22	1190	597	1066,60	1279,70
100	11	850	449	609,80	731,70
	22	1487	747	1195,60	1434,80
120	11	1020	539	681,70	818,20
	22	1784	896	1333,20	1600,00
140	11	1190	629	752,40	903,00
	22	2082	1045	1466,20	1759,50
160	11	1360	719	823,60	988,30
	22	2379	1194	1601,70	1922,10
180	11	1530	809	894,00	1073,00
	22	2676	1343	1736,80	2084,30
200	11	1700	899	965,90	1159,20
	22	2974	1493	1873,20	2247,70
220	11	1870	988	1036,80	1244,00
	22	3271	1642	2008,20	2409,90
240	11	2040	1078	1107,50	1329,10
	22	3569	1792	2142,40	2570,80
260	11	2210	1168	1178,40	1414,10
	22	3866	1941	2277,90	2733,50
280	11	2380	1258	1248,20	1498,00
	22	4163	2090	2410,30	2892,40
300	11	2549	1347	1318,90	1582,80
	22	4461	2240	2544,50	3053,40

	Type	Watts 75/65	Watts 55/45	£ st. colour	£ other
L H 069					
060	11	592	313	550,50	660,70
	22	1025	515	1093,80	1312,50
080	11	789	417	628,30	754,00
	22	1367	686	1243,10	1491,70
100	11	986	521	708,10	849,80
	22	1709	858	1395,10	1674,00
120	11	1183	625	789,80	947,90
	22	2051	1030	1553,10	1863,90
140	11	1381	730	872,40	1047,00
	22	2392	1201	1711,90	2054,40
160	11	1578	834	956,20	1147,50
	22	2734	1373	1873,40	2248,30
180	11	1775	938	1039,00	1246,80
	22	3076	1544	2032,40	2438,80
200	11	1972	1042	1122,60	1347,00
	22	3418	1716	2192,30	2630,80
220	11	2169	1146	1206,20	1447,60
	22	3760	1888	2353,30	2824,00
240	11	2367	1251	1289,00	1546,50
	22	4101	2059	2512,20	3014,70
260	11	2564	1355	1372,90	1647,50
	22	4443	2231	2673,40	3208,20
280	11	2761	1459	1454,60	1745,60
	22	4785	2402	2831,60	3398,00
300	11	2958	1563	1538,30	1846,00
	22	5127	2574	2992,50	3591,10

	Type	Watts 75/65	Watts 55/45	£ st. colour	£ other
L H 081					
060	11	671	355	617,20	740,50
	22	1143	574	1229,80	1475,70
080	11	895	473	701,70	842,10
	22	1524	765	1392,80	1671,20
100	11	1119	591	787,30	944,70
	22	1905	957	1557,60	1869,20
120	11	1342	709	879,00	1054,60
	22	2286	1148	1734,50	2081,50
140	11	1566	827	969,70	1163,60
	22	2667	1340	1910,40	2292,60
160	11	1790	946	1061,20	1273,70
	22	3048	1531	2087,30	2504,70
180	11	2013	1064	1152,20	1382,50
	22	3430	1723	2263,50	2716,10
200	11	2237	1182	1244,60	1493,40
	22	3811	1914	2441,00	2929,40
220	11	2461	1300	1336,20	1603,50
	22	4192	2106	2619,10	3143,00
240	11	2684	1418	1426,70	1712,00
	22	4573	2297	2793,80	3352,40
260	11	2908	1536	1518,50	1822,20
	22	4954	2488	2972,00	3566,40
280	11	3132	1655	1609,10	1931,00
	22	5335	2680	3146,90	3776,40
300	11	3356	1773	1701,80	2042,30
	22	5716	2871	3325,60	3990,80

EN442 output at 20°C room temperature

Panel Plus is available from 6cm high up to 94 cm, see:
www.theradiatorfactory.com

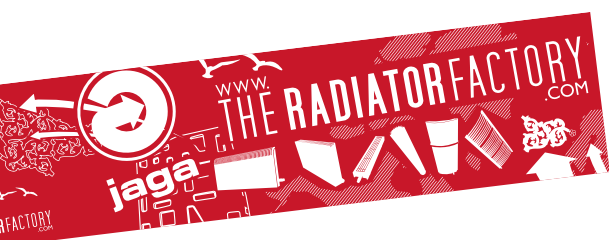

Jaga International
Verbindingslaan z/n
B-3590 Diepenbeek

Tel.: +32 (0)11 29 41 16
Fax: +32 (0)11 29 41 60
export@jaga.be

The information in this price list is correct at the time of printing.
Jaga reserves the right to change product specification at any time in line
with our policy of continuous improvement and innovation.
All prices in Euro, exclude VAT. Prices valid from 1 August 2016.
Replaces all existing price lists.