

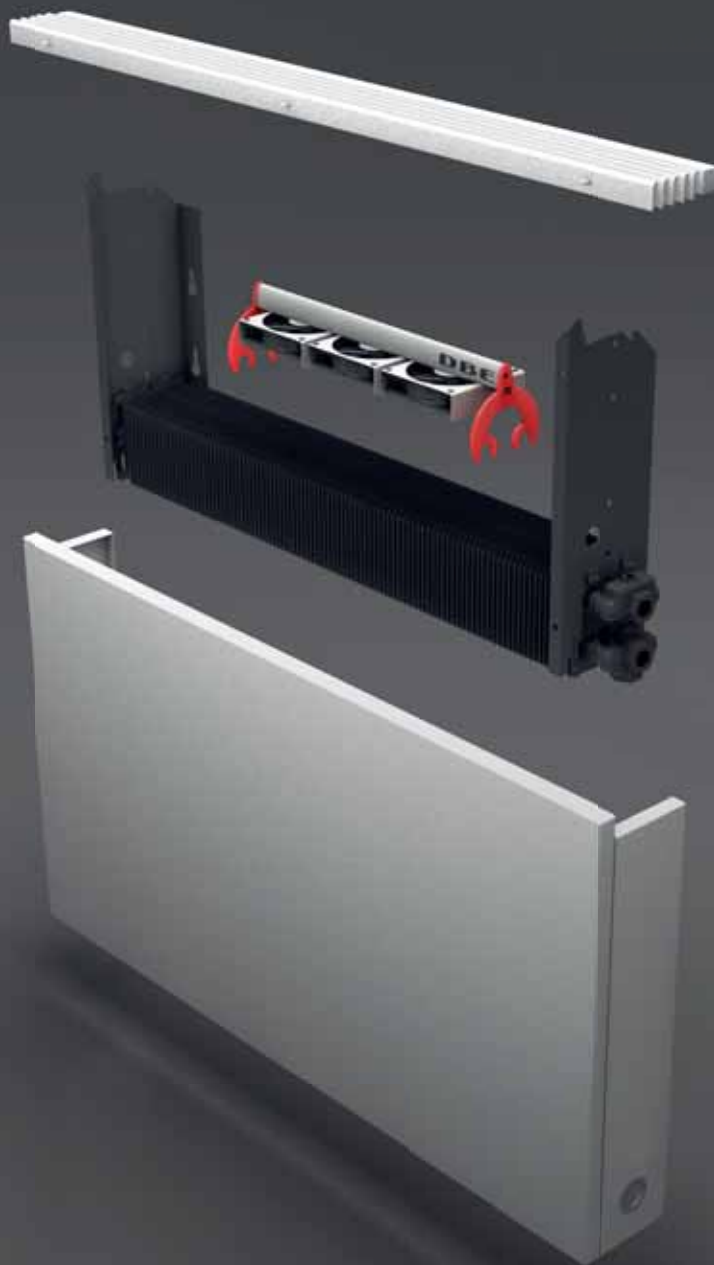

jaga



PARTS & OPTIONS

€ 2016-2017.EX



jaga





PARTS & OPTIONS

STRADA - CASING



Standard delivery

- partially pre-assembled casing
- colour 133 or 001
- cover plate in stainless steel effect for the side panel at the opposite end from the valve
- delivered in a cardboard box, which can also be used as protection on site after installation

ORDERING CODE

code height length type col.
CSTW. HHH LLL TT. XXX

L	Type	H 020		H 035		H 050		H 065		H 095	
		st. colour	other	st. colour	other	st. colour	other	st. colour	other	st. colour	other
050	06	66,50	113,30	77,60	132,20	84,90	144,80	92,50	157,70	---	---
	10/11	72,60	123,80	83,70	142,50	92,10	156,80	101,60	173,50	---	---
	15/16	79,60	135,30	91,70	156,20	101,00	171,90	111,80	190,50	---	---
	20/21	86,40	147,20	98,50	167,90	108,90	185,70	119,70	204,10	---	---
060	06	72,00	122,70	84,50	144,10	92,50	157,70	100,80	171,90	118,10	201,00
	10/11	78,50	133,80	90,90	154,90	99,90	170,20	110,50	188,20	127,60	217,40
	15/16	84,20	143,20	97,90	166,60	107,60	183,30	119,40	203,20	138,70	235,90
	20/21	91,60	156,00	105,10	179,10	116,20	198,10	127,90	217,80	147,20	250,40
070	06	74,80	127,60	88,00	149,90	97,30	166,10	106,70	182,00	124,80	212,60
	10/11	83,40	141,90	96,30	164,10	106,70	182,10	118,20	201,50	136,40	232,30
	15/16	89,80	152,70	103,80	177,10	115,30	196,50	127,80	217,90	148,10	252,20
	20/21	100,30	170,60	114,30	194,90	127,10	216,30	139,40	237,50	159,60	271,80
080	06	79,20	135,10	93,30	159,00	103,60	176,70	114,50	195,00	135,00	230,10
	10/11	87,80	149,50	101,70	173,30	113,10	192,60	126,00	214,60	146,70	249,70
	15/16	97,20	165,70	112,50	191,50	124,80	212,30	138,80	236,40	161,50	275,00
	20/21	107,40	182,80	122,50	208,50	136,00	231,50	150,00	255,30	172,60	293,80
090	06	83,10	141,40	99,10	168,80	109,80	187,30	121,20	206,40	143,70	244,80
	10/11	91,90	156,60	107,90	183,60	119,80	204,00	133,20	226,80	155,80	265,10
	15/16	102,60	174,70	119,70	204,10	132,50	225,60	147,10	250,50	171,80	292,40
	20/21	112,70	191,80	129,80	220,90	143,70	244,80	158,20	269,20	182,90	311,20
100	06	85,70	146,10	102,10	174,00	113,40	193,50	125,40	213,60	152,70	260,00
	10/11	96,20	163,70	112,60	191,50	125,00	212,80	138,90	236,60	166,20	283,00
	15/16	107,40	182,60	125,00	212,50	138,30	235,20	153,30	260,90	182,80	310,90
	20/21	119,10	202,80	136,50	232,50	151,10	257,40	166,10	282,80	195,50	332,70
110	06	90,30	154,00	107,70	183,60	120,50	205,30	132,70	226,30	163,10	277,80
	10/11	101,40	172,80	118,90	202,40	132,60	225,80	147,10	250,40	177,30	302,00
	15/16	111,90	190,90	130,50	222,50	145,30	247,30	160,80	273,80	193,20	329,00
	20/21	126,30	215,10	144,90	246,50	160,70	273,50	176,20	299,80	208,60	355,00
120	06	98,50	168,00	116,10	197,80	129,90	221,20	144,60	246,30	175,90	299,30
	10/11	112,50	191,40	129,90	221,00	144,60	246,20	161,50	275,00	192,70	327,90
	15/16	125,60	213,90	144,20	245,70	159,90	272,20	178,00	302,90	211,30	359,40
	20/21	145,30	247,40	163,80	279,10	180,70	307,80	198,70	338,10	231,90	394,70
140	06	103,60	176,50	123,50	210,20	139,20	237,10	154,90	263,80	192,20	326,80
	10/11	118,50	202,10	138,50	235,60	155,10	264,20	172,90	294,60	210,10	357,60
	15/16	131,30	223,40	152,30	259,40	169,90	289,20	188,90	321,60	228,30	388,20
	20/21	150,30	255,80	171,30	291,40	190,10	323,50	209,00	355,50	248,20	422,30
160	06	121,90	207,60	144,80	246,40	163,90	279,10	182,50	310,50	---	---
	10/11	139,40	237,60	162,20	276,20	182,40	310,50	203,10	345,80	---	---
	15/16	155,50	264,50	179,20	305,20	200,40	341,00	222,20	378,20	---	---
	20/21	177,10	301,40	201,00	341,90	223,10	379,80	245,00	416,60	---	---
180	06	130,80	222,70	156,00	265,50	176,60	300,70	197,20	335,80	---	---
	10/11	151,50	258,10	176,60	300,80	198,50	337,70	221,10	376,50	---	---
	15/16	169,50	288,40	195,90	333,40	218,40	371,70	242,30	412,30	---	---
	20/21	191,20	325,10	217,50	369,90	241,10	410,30	264,90	450,70	---	---
200	06	146,30	249,20	173,60	295,40	196,10	333,80	219,10	373,00	---	---
	10/11	167,60	285,40	194,70	331,40	218,30	371,70	243,40	414,50	---	---
	15/16	189,80	322,90	218,10	371,10	242,70	412,70	268,90	457,60	---	---
	20/21	212,10	360,80	240,20	408,70	266,00	452,40	292,20	497,10	---	---
240	06	187,60	319,50	219,20	373,10	246,20	419,00	273,50	465,60	---	---
	10/11	212,60	361,80	244,10	415,30	272,20	462,80	301,60	513,20	---	---
	15/16	239,00	406,60	271,70	462,30	300,60	511,20	331,30	563,50	---	---
	20/21	267,00	454,40	299,70	509,90	329,80	561,00	360,40	613,00	---	---
280	06	210,00	357,40	245,50	418,20	277,00	471,30	308,10	524,30	---	---
	10/11	238,00	405,10	273,50	465,60	305,90	520,50	339,30	577,20	---	---
	15/16	268,80	457,20	305,60	520,00	338,70	576,10	373,10	634,80	---	---
	20/21	299,50	509,30	336,00	571,70	370,50	630,20	405,00	688,60	---	---

HEAT EXCHANGER - STRADA

L	STANDARD					TWIN						
	Type	H 020	035	050	065	095	Type	H 020	035	050	065	095
050	---	---	---	---	---	---	06	102,20	143,20	145,30	147,50	---
	10	79,20	84,60	86,60	89,90	---	11	---	168,80	172,00	175,40	---
	15	100,70	105,10	109,30	113,60	---	16	---	205,70	208,80	214,00	---
	20	121,30	126,60	131,90	139,40	---	21	---	219,60	224,70	231,20	---
	---	---	---	---	---	---	06	108,60	151,90	153,80	156,00	158,10
060	---	---	---	---	---	---	11	---	178,90	182,30	185,40	188,40
	10	85,20	90,50	92,50	95,80	98,80	16	---	221,20	224,30	229,40	235,90
	15	109,50	113,90	118,10	122,40	128,80	21	---	238,80	244,00	250,50	257,00
	20	133,70	138,80	144,00	151,70	156,80	06	125,40	174,40	176,40	178,60	180,70
	---	---	---	---	---	---	11	---	205,40	208,60	211,90	214,80
070	---	---	---	---	---	---	16	---	257,60	260,70	266,00	272,50
	10	99,60	105,10	107,10	110,40	113,30	21	---	280,90	286,30	292,70	299,10
	15	129,40	133,80	138,10	142,10	148,60	06	133,50	184,90	187,00	189,20	191,30
	20	159,90	165,10	170,30	178,00	183,00	11	---	218,60	222,00	225,00	228,30
	---	---	---	---	---	---	16	---	276,90	279,80	285,10	291,50
080	---	---	---	---	---	---	21	---	303,50	308,60	315,10	321,50
	10	107,00	112,50	114,30	117,60	120,60	06	139,90	193,70	195,80	198,00	200,00
	15	140,30	144,60	148,70	153,00	159,50	11	---	229,10	232,30	235,60	238,60
	20	173,90	179,10	184,50	192,00	197,10	16	---	294,70	297,80	303,00	309,40
	---	---	---	---	---	---	21	---	323,70	329,00	335,40	341,90
090	---	---	---	---	---	---	06	153,80	212,20	214,30	216,50	218,40
	10	112,90	118,30	120,40	123,50	126,60	11	---	251,90	255,00	258,30	261,50
	15	149,80	154,20	158,40	162,80	169,20	16	---	325,50	328,40	333,70	340,10
	20	186,70	191,80	197,10	204,80	209,90	21	---	361,20	366,30	372,90	379,40
	---	---	---	---	---	---	06	162,10	223,00	225,00	227,20	229,30
100	---	---	---	---	---	---	11	---	264,30	267,40	270,70	273,70
	10	125,60	131,00	132,90	136,30	139,20	16	---	344,30	347,30	352,50	359,00
	15	167,00	171,40	175,70	179,90	186,20	21	---	383,90	389,20	395,50	402,00
	20	210,00	215,30	220,50	228,30	233,30	06	169,80	233,70	235,80	238,00	240,00
	---	---	---	---	---	---	11	---	277,30	280,50	283,80	286,80
110	---	---	---	---	---	---	16	---	363,50	366,60	371,90	378,30
	10	132,30	137,90	139,80	143,10	146,10	21	---	406,10	411,60	418,00	424,30
	15	178,20	182,60	186,80	191,10	197,50	06	187,40	260,60	263,70	266,90	270,00
	20	224,20	229,30	234,50	242,20	247,30	11	---	310,80	315,60	320,50	325,00
	---	---	---	---	---	---	16	---	410,70	415,30	423,30	432,80
120	---	---	---	---	---	---	21	---	495,10	502,80	512,40	522,30
	10	139,50	145,10	147,20	150,40	153,40	06	220,80	305,10	308,20	311,50	---
	15	188,30	192,70	196,90	201,20	207,70	11	---	364,00	368,90	373,60	---
	20	238,10	243,30	248,60	256,30	261,50	16	---	487,50	492,10	500,00	---
	---	---	---	---	---	---	21	---	586,70	594,80	604,40	---
140	---	---	---	---	---	---	06	237,90	327,80	330,80	334,10	---
	10	155,80	164,00	167,10	171,90	176,40	11	---	391,40	396,20	401,00	---
	15	212,40	219,00	225,30	231,70	241,50	16	---	528,70	533,30	541,20	---
	20	290,40	298,40	306,30	317,60	325,40	21	---	636,00	643,90	653,50	---
	---	---	---	---	---	---	06	254,40	350,10	353,10	356,50	---
160	---	---	---	---	---	---	11	---	418,50	423,40	428,10	---
	10	185,40	193,70	196,70	201,50	---	16	---	607,50	612,20	620,00	---
	15	255,40	262,00	268,40	274,80	---	21	---	685,00	692,80	702,60	---
	20	348,10	356,00	363,80	375,30	---	06	314,50	433,10	437,20	441,60	---
	---	---	---	---	---	---	11	---	519,40	525,90	532,40	---
180	---	---	---	---	---	---	16	---	755,10	761,10	771,60	---
	10	200,70	208,70	211,70	216,60	---	21	---	858,00	868,50	881,40	---
	15	278,10	284,80	291,20	297,60	---	06	353,20	484,90	489,00	493,40	---
	20	378,70	386,50	394,40	405,80	---	11	---	580,70	587,20	593,50	---
	---	---	---	---	---	---	16	---	846,30	852,40	862,90	---
200	---	---	---	---	---	---	21	---	966,00	976,60	989,40	---
	10	215,70	223,90	226,90	231,60	---	06	353,20	484,90	489,00	493,40	---
	15	321,90	328,50	335,00	341,30	---	11	---	580,70	587,20	593,50	---
	20	409,40	417,20	425,10	436,60	---	16	---	846,30	852,40	862,90	---
	---	---	---	---	---	---	21	---	966,00	976,60	989,40	---
240	---	---	---	---	---	---	06	353,20	484,90	489,00	493,40	---
	10	269,20	280,10	284,20	290,70	---	11	---	580,70	587,20	593,50	---
	15	401,80	410,70	419,20	427,70	---	16	---	846,30	852,40	862,90	---
	20	514,20	524,80	535,30	550,50	---	21	---	966,00	976,60	989,40	---
	---	---	---	---	---	---	06	353,20	484,90	489,00	493,40	---
280	---	---	---	---	---	---	11	---	580,70	587,20	593,50	---
	10	303,60	314,50	318,50	324,90	---	16	---	846,30	852,40	862,90	---
	15	452,40	461,30	469,80	478,40	---	21	---	966,00	976,60	989,40	---
	20	582,00	592,50	602,90	618,20	---	06	353,20	484,90	489,00	493,40	---
	---	---	---	---	---	---	11	---	580,70	587,20	593,50	---

STANDARD

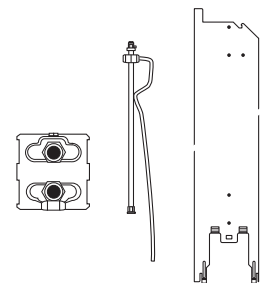

Standard delivery

- Low-H₂O heat exchanger
- wall brackets
- extended air vent
- fixing kit
- drain plug

ORDERING CODE

code height length type
HSTW. HHH LLL TT

TWIN

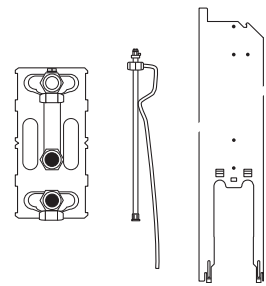

Standard delivery

- Twin Low-H₂O heat exchanger
- wall brackets
- extended air vent
- fixing kit
- drain plug

ORDERING CODE

code height length type
HSTW. HHH LLL TT

DBE OPTION

See DBE renovation set

LINEA PLUS - CASING



Standard delivery

- partially pre-assembled casing
- colour 133 or 001
- delivered in a cardboard box, which can also be used as protection on site after installation

ORDERING CODE

code	height	length	type	col.
CLIW.	HHH	LLL	TT.	XXX

L	Type	H 020		H 035		H 050		H 065		H 095	
		st. colour	other	st. colour	other	st. colour	other	st. colour	other	st. colour	other
050	10/11	51,00	87,00	59,70	102,00	68,00	116,00	76,90	131,30	---	---
	15/16	54,50	93,10	63,60	108,60	73,00	124,30	83,30	141,90	---	---
	20/21	58,60	99,90	68,70	116,90	78,90	134,20	89,10	151,90	---	---
060	10/11	54,50	92,90	64,70	110,50	73,50	125,50	83,30	142,00	100,70	171,70
	15/16	57,40	98,10	68,00	116,10	77,90	132,90	89,00	151,80	108,60	184,90
	20/21	61,80	105,50	73,40	125,20	84,20	143,40	95,30	162,50	114,30	194,60
070	10/11	56,80	96,80	67,60	115,40	77,90	132,90	88,60	151,10	107,10	182,40
	15/16	60,20	102,80	71,40	121,80	82,60	141,20	94,80	161,60	115,30	196,40
	20/21	65,70	112,10	77,90	132,70	90,10	153,60	102,20	174,20	122,10	207,90
080	10/11	60,80	103,50	72,50	123,50	83,70	142,60	95,90	163,20	116,80	198,90
	15/16	65,30	111,20	77,40	131,70	89,60	152,60	103,20	175,60	126,00	214,50
	20/21	70,80	120,50	83,70	142,50	96,90	165,00	110,60	188,10	132,80	226,20
090	10/11	64,10	109,30	77,80	132,60	89,60	152,60	102,10	174,00	125,20	213,00
	15/16	69,10	117,70	83,30	141,60	96,00	163,50	109,90	187,20	134,80	229,50
	20/21	74,40	126,90	89,50	152,40	103,10	175,70	117,20	199,60	141,50	240,90
100	10/11	66,70	113,60	80,90	137,60	93,00	158,60	106,20	180,90	134,00	227,90
	15/16	72,00	122,90	86,50	147,40	99,80	170,10	114,30	194,80	144,00	245,20
	20/21	78,50	133,80	93,90	159,90	107,90	184,20	122,70	209,10	151,90	258,30
110	10/11	70,00	119,50	85,30	145,30	98,80	168,30	112,50	191,50	143,10	243,80
	15/16	74,90	127,80	90,50	154,10	105,10	178,90	120,20	204,50	152,80	260,10
	20/21	81,90	139,70	98,40	167,50	113,90	193,90	129,00	219,70	161,20	274,20
120	10/11	73,90	126,00	89,00	151,90	103,70	176,70	119,70	204,10	151,30	257,70
	15/16	79,30	135,20	94,90	161,70	110,60	188,40	128,00	218,10	161,60	275,00
	20/21	86,60	147,70	103,10	175,80	119,70	204,00	137,10	233,80	170,30	289,60
140	10/11	80,20	136,80	98,00	166,70	114,50	194,80	131,50	224,00	169,10	287,50
	15/16	86,50	147,60	104,50	178,10	122,10	208,00	140,60	239,40	180,20	306,40
	20/21	94,90	161,80	113,90	193,80	132,30	225,30	150,80	256,90	189,80	322,90
160	10/11	95,90	163,30	116,20	198,10	136,40	232,10	156,10	266,00	---	---
	15/16	102,70	174,80	123,50	210,20	144,50	246,10	165,90	282,10	---	---
	20/21	112,60	191,60	134,30	228,60	156,30	266,00	177,70	302,20	---	---
180	10/11	105,40	179,80	128,30	218,70	150,00	255,30	171,90	292,60	---	---
	15/16	113,80	193,90	137,00	233,50	159,60	271,80	183,00	311,40	---	---
	20/21	123,60	210,70	147,80	251,80	171,40	291,70	194,70	331,50	---	---
200	10/11	117,20	199,60	142,00	241,90	165,60	281,70	189,80	323,30	---	---
	15/16	126,00	214,50	151,30	257,50	175,80	299,10	201,50	342,90	---	---
	20/21	136,80	233,00	163,00	277,30	188,30	320,50	214,20	364,60	---	---
220	10/11	138,70	236,00	165,90	282,50	191,80	326,70	218,10	371,00	---	---
	15/16	148,40	252,50	176,10	299,60	203,00	345,60	230,80	392,20	---	---
	20/21	159,60	271,80	188,30	320,40	216,10	367,90	243,80	414,90	---	---
240	10/11	148,30	252,60	177,70	302,30	205,40	349,50	234,00	398,50	---	---
	15/16	159,10	271,00	188,80	321,20	217,60	370,20	247,70	421,50	---	---
	20/21	171,40	291,80	201,90	343,60	231,60	394,20	261,90	445,60	---	---
260	10/11	157,70	268,50	188,90	321,30	219,10	373,10	249,70	424,90	---	---
	15/16	168,40	286,50	199,90	340,00	231,20	393,60	263,20	447,70	---	---
	20/21	182,60	310,70	215,00	365,60	247,20	420,70	279,40	475,20	---	---
280	10/11	165,90	282,20	199,10	339,00	231,30	393,60	263,80	448,90	---	---
	15/16	178,10	302,80	211,70	360,30	244,90	416,60	278,70	474,20	---	---
	20/21	191,80	326,30	226,40	385,20	260,50	443,10	294,40	501,00	---	---

HEAT EXCHANGER - LINEA PLUS

L	STANDARD						TWIN					
	Type	H 020	035	050	065	095	Type	H 020	035	050	065	095
050	10	80,70	85,60	88,40	91,60	---	11	---	166,50	169,40	172,20	---
	15	102,20	107,00	111,00	114,80	---	16	---	203,20	206,00	210,80	---
	20	122,60	128,50	133,50	139,20	---	21	---	215,60	220,60	226,50	---
060	10	86,60	91,60	94,50	97,40	100,40	11	---	176,60	179,40	182,40	185,40
	15	111,00	115,80	119,80	123,50	129,60	16	---	218,60	221,70	226,40	232,20
	20	134,70	140,70	145,60	151,50	157,10	21	---	234,90	240,00	245,70	251,70
070	10	101,10	106,20	108,90	112,00	115,00	11	---	203,10	205,90	208,80	211,90
	15	130,80	135,70	139,50	143,40	149,40	16	---	255,00	257,90	262,60	268,70
	20	161,10	167,00	171,90	177,90	183,30	21	---	277,20	282,20	288,00	293,90
080	10	108,50	113,30	116,20	119,40	122,20	11	---	216,20	219,10	222,10	225,00
	15	141,60	146,40	150,50	154,20	160,20	16	---	274,20	277,20	281,90	287,80
	20	175,00	181,00	185,90	191,80	197,50	21	---	299,50	304,60	310,40	316,30
090	10	114,30	119,40	122,20	125,30	128,10	11	---	226,80	229,60	232,50	235,60
	15	151,30	156,00	160,20	163,90	169,80	16	---	292,20	295,10	299,90	305,80
	20	187,70	193,70	198,70	204,50	210,10	21	---	319,80	324,90	330,60	336,60
100	10	127,20	132,10	134,80	138,10	140,90	11	---	249,50	252,30	255,30	258,30
	15	168,40	173,30	177,20	181,00	187,00	16	---	322,80	325,80	330,50	336,40
	20	211,20	217,20	222,10	227,90	233,60	21	---	357,20	362,40	368,10	374,10
110	10	134,00	138,80	141,60	144,80	147,60	11	---	261,90	264,70	267,60	270,70
	15	179,80	184,50	188,40	192,20	198,20	16	---	341,80	344,60	349,30	355,20
	20	225,20	231,20	236,00	242,10	247,60	21	---	380,00	385,00	390,80	396,70
120	10	144,60	152,00	156,30	160,80	165,20	11	---	282,70	287,00	291,40	295,90
	15	194,30	201,30	207,50	213,00	222,00	16	---	369,90	374,20	381,30	390,20
	20	244,10	253,10	260,50	269,20	277,70	21	---	412,00	419,60	428,30	437,20
140	10	158,10	165,60	169,80	174,40	178,70	11	---	307,20	311,60	315,80	320,50
	15	214,70	222,00	227,90	233,60	242,40	16	---	407,00	411,40	418,40	427,40
	20	292,30	301,20	308,50	317,40	325,90	21	---	489,10	496,80	505,40	514,30
160	10	187,70	195,20	199,40	204,10	---	11	---	360,60	364,80	369,10	---
	15	257,60	264,70	270,90	276,40	---	16	---	483,70	488,00	495,20	---
	20	350,00	358,80	366,10	375,10	---	21	---	581,10	588,60	597,20	---
180	10	203,00	210,20	214,60	219,10	---	11	---	387,90	392,10	396,50	---
	15	280,50	287,60	293,70	299,40	---	16	---	524,90	529,30	536,30	---
	20	380,40	389,30	396,70	405,60	---	21	---	630,20	637,70	646,40	---
200	10	218,00	225,30	229,60	234,20	---	11	---	414,90	419,20	423,60	---
	15	324,20	331,30	337,50	343,00	---	16	---	603,80	608,10	615,20	---
	20	411,10	419,90	427,50	436,30	---	21	---	679,10	686,90	695,30	---
220	10	252,60	259,90	264,30	268,80	---	11	---	477,00	481,40	485,70	---
	15	375,70	382,80	388,90	394,50	---	16	---	696,60	701,00	708,00	---
	20	478,40	487,20	494,70	503,60	---	21	---	786,70	794,20	802,80	---
240	10	272,50	282,20	288,00	294,00	---	11	---	514,60	520,50	526,30	---
	15	405,00	414,40	422,60	430,00	---	16	---	750,00	755,70	765,20	---
	20	516,60	528,50	538,30	550,20	---	21	---	850,20	860,40	871,80	---
260	10	290,00	299,90	305,70	311,60	---	11	---	546,30	552,00	557,80	---
	15	430,80	440,40	448,50	455,90	---	16	---	796,50	802,40	811,90	---
	20	550,70	562,50	572,40	584,20	---	21	---	904,40	914,60	926,10	---
280	10	306,60	316,50	322,10	328,30	---	11	---	575,90	581,70	587,50	---
	15	455,70	465,00	473,20	480,70	---	16	---	841,10	846,90	856,40	---
	20	584,30	596,30	606,20	617,90	---	21	---	958,30	968,40	979,90	---

STANDARD

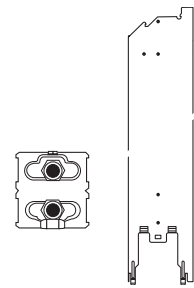

Standard delivery

- Low-H₂O heat exchanger
- wall brackets
- angled air vent
- fixing kit
- drain plug

ORDERING CODE

code height length type
HLIW. HHH LLL TT

TWIN

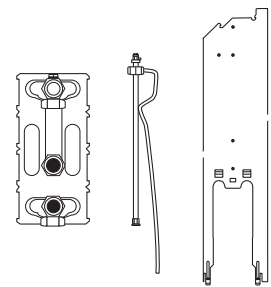

standard delivery

- Twin Low-H₂O heat exchanger
- wall brackets
- extended air vent
- fixing kit
- drain plug

ORDERING CODE

code height length type
HLIW. HHH LLL TT

DBE OPTION

See DBE renovation set

TEMPO - CASING



Standard delivery

- kit existing of:
 - grille
 - front panel
 - open side panel for valve connection
 - closed side panel
- colour 101
- compact packaging with cardboard corners and shrink wrapping

ORDERING CODE

code	height	length	type	col.
CTEW.	HHH	LLL	TT.	101

		H 020	H 030	H 040	H 050	H 060	H 070	H 090
L	Type							
040	10/11	40,10	46,90	53,70	62,00	68,80	76,20	90,90
	15/16	43,80	51,10	59,00	68,10	75,60	82,40	98,50
	20/21	48,20	56,50	64,80	74,10	83,00	90,20	108,30
050	10/11	42,80	50,00	57,30	65,90	73,20	81,10	96,50
	15/16	46,60	54,40	62,60	72,20	80,10	87,50	104,20
	20/21	51,00	59,90	68,60	78,30	87,50	95,10	114,00
060	10/11	45,40	53,60	61,80	71,50	79,90	88,70	106,20
	15/16	49,70	58,50	67,70	78,40	87,20	95,60	114,30
	20/21	54,50	64,40	74,10	84,70	95,00	103,70	124,70
070	10/11	50,10	59,20	68,50	79,10	88,30	98,10	117,50
	15/16	55,30	65,10	75,30	86,80	96,70	105,70	126,60
	20/21	60,70	71,40	82,10	93,80	104,90	114,70	137,30
080	10/11	52,10	61,80	71,50	82,60	92,40	102,70	123,10
	15/16	57,90	68,10	78,90	90,90	101,10	110,90	132,60
	20/21	63,70	75,10	86,10	98,30	109,90	120,20	144,00
090	10/11	55,90	66,60	77,30	89,30	99,90	111,10	133,50
	15/16	61,60	73,00	84,50	97,50	108,70	119,40	143,10
	20/21	68,50	80,70	92,80	105,70	118,40	129,60	155,20
100	10/11	60,00	71,50	83,30	96,30	107,90	120,20	144,50
	15/16	66,00	78,30	90,90	105,00	117,20	128,80	154,60
	20/21	73,40	86,60	99,80	113,80	127,50	139,50	167,30
110	10/11	63,40	76,10	88,70	102,80	115,50	128,70	155,10
	15/16	71,10	84,30	98,00	113,10	126,30	139,00	166,70
	20/21	77,90	92,20	106,30	121,30	136,10	149,10	178,80
120	10/11	65,30	78,30	91,50	105,90	119,10	132,60	159,90
	15/16	73,40	87,00	101,00	116,60	130,20	143,40	171,90
	20/21	81,20	95,90	110,50	125,90	141,00	154,60	185,20
140	10/11	74,20	89,90	105,40	122,60	138,30	154,50	186,80
	15/16	83,00	99,10	115,60	133,80	149,90	165,60	199,20
	20/21	91,60	108,80	125,90	144,00	161,60	177,80	213,40
160	10/11	82,40	99,40	116,60	135,00	152,30	169,80	205,10
	15/16	93,20	110,80	128,80	148,30	165,90	183,00	219,70
	20/21	104,20	122,90	141,30	160,80	180,00	197,50	236,00
180	10/11	89,00	107,90	127,10	147,30	166,20	185,70	224,70
	15/16	100,70	120,20	140,20	161,50	180,90	199,90	240,20
	20/21	112,40	132,70	153,30	174,50	195,50	214,80	257,30
200	10/11	98,40	119,70	141,20	164,00	185,40	207,40	251,30
	15/16	111,50	133,50	155,80	179,60	201,50	222,90	268,20
	20/21	124,10	147,10	169,90	193,70	217,20	238,90	286,20
220	10/11	108,60	131,50	154,40	178,50	201,40	224,80	271,40
	15/16	123,50	146,90	170,70	196,00	219,50	242,30	290,30
	20/21	138,20	162,50	186,90	212,10	236,90	260,20	310,40
240	10/11	116,10	140,90	165,90	192,20	217,00	242,40	293,30
	15/16	132,10	157,40	183,20	210,60	236,00	260,90	313,00
	20/21	147,10	173,60	199,80	227,10	254,00	279,40	333,50
260	10/11	122,90	149,10	175,50	203,20	229,40	256,30	310,10
	15/16	140,40	167,20	194,40	223,00	250,00	276,30	331,30
	20/21	156,80	184,70	212,40	241,10	269,40	296,20	353,30
280	10/11	135,90	164,50	193,20	223,20	252,00	281,40	339,70
	15/16	154,40	183,50	213,30	244,40	273,50	302,30	361,90
	20/21	171,30	201,40	231,60	262,60	293,40	322,50	384,30
300	10/11	141,60	171,80	201,90	233,50	263,70	294,20	355,60
	15/16	161,10	191,70	222,80	255,40	286,10	316,20	378,80
	20/21	178,90	210,70	242,30	274,90	306,90	337,60	402,20

MAXI - CASING

MAXI WT



Standard delivery

- completely pre-assembled casing
- colour 233 or 001
- delivered in a cardboard box, which can also be used as protection on site after installation

ORDERING CODE

code height length type colour model conn.
CMAW. HHH LLL TT. XXX/WT /70

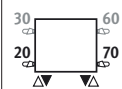

standard connection right (/70)
connection left (/20)
option high level valve left (/30)
option high level valve right (/60)
remote controlled valve (/00)

L	Type	H 044		H 059		H 074	
		st. colour	other	st. colour	other	st. colour	other
063	10/11	265,20	318,30	297,80	357,30	330,40	396,50
	15/16	273,90	328,80	307,40	369,00	341,60	409,90
	20/21	282,90	339,50	317,70	381,30	352,80	423,40
083	10/11	278,70	334,50	315,40	378,50	351,50	421,90
	15/16	288,60	346,40	326,60	391,90	363,50	436,20
	20/21	298,80	358,60	337,20	404,70	376,10	451,30
103	10/11	293,10	351,80	333,10	399,60	372,90	447,40
	15/16	303,80	364,50	344,60	413,60	385,40	462,40
	20/21	314,50	377,30	356,40	427,60	398,20	477,80
123	10/11	306,60	367,90	350,30	420,30	394,20	473,00
	15/16	319,30	383,10	363,50	436,20	408,80	490,70
	20/21	331,50	397,70	376,80	452,20	423,40	508,00
143	10/11	333,10	399,60	382,40	459,00	433,00	519,80
	15/16	345,60	414,60	396,60	475,90	447,70	537,30
	20/21	357,50	429,10	410,10	492,10	462,70	555,20
163	10/11	346,50	415,90	400,60	480,70	454,50	545,50
	15/16	360,00	432,10	415,10	498,10	470,00	564,10
	20/21	373,20	447,80	429,90	515,90	485,60	582,80

MAXI WF



Standard delivery

- completely pre-assembled casing
- colour 233 or 001
- delivered in a cardboard box, which can also be used as protection on site after installation

ORDERING CODE

code height length type colour model conn.
CMAW. HHH LLL TT. XXX/WF /70

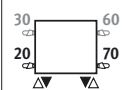

standard connection right (/70)
connection left (/20)
option high level valve left (/30)
option high level valve right (/60)
remote controlled valve (/00)

L	Type	H 044		H 059		H 074	
		st. colour	other	st. colour	other	st. colour	other
063	10/11	293,90	352,70	326,60	391,90	359,10	430,80
	15/16	305,80	366,90	339,70	407,60	373,20	447,80
	20/21	317,30	380,80	352,40	422,80	387,20	464,60
083	10/11	308,20	369,80	344,10	412,90	380,50	456,50
	15/16	320,70	384,90	358,40	430,00	395,90	474,90
	20/21	333,80	400,70	372,40	447,00	410,80	493,00
103	10/11	321,70	386,10	361,50	433,90	401,30	481,50
	15/16	335,90	403,10	376,80	452,20	418,20	501,90
	20/21	350,30	420,30	392,20	470,50	434,30	521,10
123	10/11	335,90	403,10	379,20	455,00	422,90	507,50
	15/16	350,90	421,20	395,90	474,90	440,40	528,50
	20/21	365,90	439,10	412,20	494,70	458,40	550,20
143	10/11	363,10	435,80	412,70	495,30	462,70	555,20
	15/16	380,00	456,00	431,20	517,40	482,80	579,40
	20/21	397,60	477,10	450,10	540,20	502,70	603,30
163	10/11	376,80	452,20	430,20	516,20	483,70	580,50
	15/16	395,20	474,30	450,10	540,20	505,20	606,20
	20/21	413,80	496,50	470,00	564,10	526,20	631,30

CASING - MAXI

L	Type	H 044		H 059		H 074	
		st. colour	other	st. colour	other	st. colour	other
063	10/11	272,60	327,00	305,00	366,00	337,80	405,40
	15/16	281,70	338,00	315,40	378,50	348,80	418,60
	20/21	291,10	349,20	325,70	390,80	360,00	432,10
083	10/11	285,70	342,70	322,10	386,50	358,70	430,40
	15/16	295,90	355,10	333,40	400,10	370,30	444,50
	20/21	306,10	367,30	344,10	412,90	382,40	459,00
103	10/11	298,80	358,60	338,60	406,20	378,40	454,00
	15/16	308,90	370,70	350,30	420,30	391,80	470,10
	20/21	319,80	383,80	361,90	434,40	404,40	485,30
123	10/11	311,90	374,30	355,20	426,20	398,90	478,70
	15/16	324,20	389,00	368,80	442,60	413,80	496,50
	20/21	335,90	403,10	382,40	459,00	427,80	513,30
143	10/11	336,30	403,50	386,00	463,20	436,10	523,20
	15/16	348,80	418,60	399,90	480,10	451,20	541,40
	20/21	361,20	433,40	414,20	497,00	466,20	559,50
163	10/11	349,50	419,40	402,90	483,40	456,50	547,80
	15/16	363,10	435,80	417,40	500,90	472,60	567,10
	20/21	376,10	451,30	432,20	518,60	488,70	586,30

MAXI FT



Standard delivery

- completely pre-assembled casing
- colour 233 or 001
- delivered in a cardboard box, which can also be used as protection on site after installation

ORDERING CODE

code	height	length	type	colour	model	conn.
CMAW.	HHH	LLL	TT.	XXX/FT		/70

standard connection right (/70)
 connection left (/20)
 option high level valve left (/30)
 option high level valve right (/60)
 remote controlled valve (/00)

L	Type	H 044		H 059		H 074	
		st. colour	other	st. colour	other	st. colour	other
063	10/11	301,70	361,90	334,40	401,30	367,00	440,50
	15/16	313,30	376,00	347,00	416,50	381,30	457,60
	20/21	325,00	390,10	359,60	431,60	394,50	473,40
083	10/11	314,90	377,80	350,90	421,20	387,20	464,60
	15/16	327,50	392,90	365,20	438,20	402,60	483,00
	20/21	340,70	408,80	379,20	455,00	418,20	501,90
103	10/11	327,50	392,90	367,50	441,00	407,30	488,80
	15/16	341,60	409,90	382,40	459,00	423,90	508,70
	20/21	356,00	427,20	398,20	477,80	440,40	528,50
123	10/11	340,70	408,80	384,40	461,30	427,80	513,30
	15/16	356,40	427,60	400,60	480,70	445,40	534,50
	20/21	371,80	446,00	417,10	500,50	462,70	555,20
143	10/11	365,90	439,10	416,10	499,30	466,20	559,50
	15/16	383,60	460,30	434,60	521,50	486,00	583,40
	20/21	401,00	481,10	453,60	544,30	506,20	607,30
163	10/11	379,20	455,00	433,00	519,80	486,80	584,10
	15/16	398,20	477,80	452,80	543,30	507,60	609,10
	20/21	416,60	500,00	472,60	567,10	528,90	634,60

MAXI FF



Standard delivery

- completely pre-assembled casing
- colour 233 or 001
- delivered in a cardboard box, which can also be used as protection on site after installation

ORDERING CODE

code	height	length	type	colour	model	conn.
CMAW.	HHH	LLL	TT.	XXX/FF		/70

standard connection right (/70)
 connection left (/20)
 option high level valve left (/30)
 option high level valve right (/60)
 remote controlled valve (/00)

MAXI-HEAT EXCHANGER

STANDARD

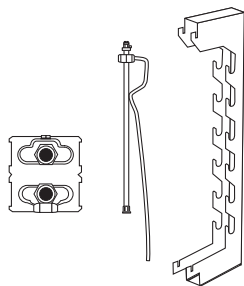

Standard delivery

- Low-H₂O heat exchanger
- wall brackets
- extended air vent
- fixing kit
- drain plug

ORDERING CODE

code height length type
HMAW. HHH LLL TT

TWIN

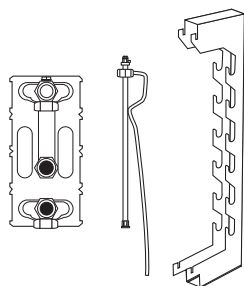

Standard delivery

- Twin Low-H₂O heat exchanger
- wall brackets
- extended air vent
- fixing kit
- drain plug

ORDERING CODE

code height length type
HMAW. HHH LLL TT

L	STANDARD			TWIN				
	Type	H 044	059	074	Type	H 044	059	074
063	10	118,00	123,70	128,50	11	199,10	205,00	209,70
	15	141,00	146,90	152,00	16	239,90	245,70	250,80
	20	165,00	169,80	175,70	21	255,40	260,30	266,20
083	10	139,80	145,60	150,40	11	238,80	244,70	249,40
	15	171,70	177,70	182,70	16	295,50	301,40	306,40
	20	205,30	210,10	215,90	21	319,90	324,90	330,60
103	10	158,40	164,30	169,10	11	272,10	277,80	282,60
	15	198,50	204,40	209,60	16	344,10	350,00	355,00
	20	241,30	246,20	252,00	21	377,70	382,70	388,50
123	10	172,50	178,30	183,00	11	297,40	303,20	308,00
	15	219,90	225,80	230,90	16	382,20	388,20	393,20
	20	269,40	274,40	280,10	21	422,90	427,80	433,50
143	10	205,20	213,80	220,80	11	341,10	349,80	356,90
	15	259,80	268,70	276,20	16	438,80	447,60	455,40
	20	337,60	344,80	353,50	21	520,00	527,30	535,80
163	10	234,90	243,40	250,60	11	394,30	403,00	410,00
	15	302,60	311,50	319,20	16	515,60	524,50	532,00
	20	395,20	402,60	411,30	21	611,70	619,10	627,80

DBE OPTION

See DBE renovation set

MAXI-OPTIONS

PENCIL-PROOF GRILLE

ORDERING CODE

code length type colour
5612. 000 LLL TT. XXX /MAX

Unobtrusively positioned below the standard grille. Optional pencil-proof grille: to stop smaller objects or waste falling within the casing. Lacquered in the same colour as the casing. Only for Maxi WT and FT.

Output correction factor WT: 0.87

Output correction factor FT: 0.92



L	Type		
	10/11	15/16	20/21
063	20,60	22,50	23,80
083	21,90	24,50	25,90
103	23,50	26,40	28,20
123	25,00	29,40	31,70
143	27,90	32,10	35,10
163	28,20	33,60	36,50

BASE GRILLE

ORDERING CODE

code length type colour
5613. 000 LLL TT. XXX /MAX

Screens the bottom of the casing. Lacquered in the same colour as the casing. Only for Maxi WF and WT.

Output correction factor WF: 0.92

Output correction factor WT: 0.87

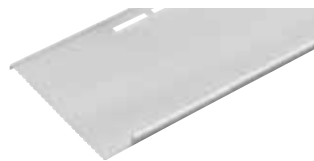

L	Type		
	10/11	15/16	20/21
063	27,30	29,40	30,70
083	28,90	31,20	32,70
103	30,20	33,30	35,10
123	32,10	36,50	39,10
143	36,10	40,80	43,50
163	37,10	42,00	44,90

LOCKS

2 per casing: to ensure that the casing cannot be de-mounted without tools. For all models.



CODE		€
5111.010	2 pieces	14,60

SAFETY SCREWS

100 safety screws: as replacement for regular screws. Requires special tool for removal (security torx bit).



CODE		€
5111.020	screws	172,70
5111.030	bit	45,00

WALL BRACKET - MINI

Type	st. colour	other
05/06	15,60	17,50
09/10/11	15,60	17,50
14/15/16	15,60	17,50
19/20/21	15,60	17,50

WALL BRACKET

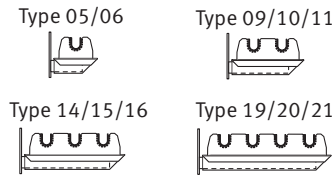

ORDERING CODE

code type colour
5205. 000 000 TT. XXX /W

Number of wall fixings for casing length:
from 060 to 160 cm: min. 2 brackets
from 180 to 300 cm: min. 3 brackets

FEET - MINI

Foot	H	Type	st. colour	other
FS	6.5	05/06	15,60	17,50
	6.5	09/10/11	15,60	17,50
	6.5	14/15/16	15,60	17,50
	6.5	19/20/21	15,60	17,50
FM	10	05/06	15,60	17,50
	10	09/10/11	15,60	17,50
	10	14/15/16	15,60	17,50
	10	19/20/21	15,60	17,50
FL	12	05/06	15,60	17,50
	12	09/10/11	15,60	17,50
	12	14/15/16	15,60	17,50
	12	19/20/21	15,60	17,50

FIXED FEET

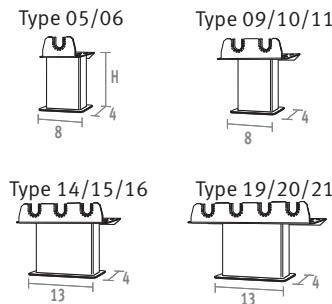

ORDERING CODE

code type colour foot
5205. 000 000 TT. XXX /FS

height 6.5 cm: **FS**
height 10 cm: **FM**
height 12 cm: **FL**

For mounting on finished floor

Number of feet for casing length:
from L 060 to 160 cm: 2 feet
from L 180 to 300 cm: 3 feet

Foot	H	Type	st. colour	other
AS	13.5 > 21	05/06	44,80	50,20
	13.5 > 21	09/10/11	44,80	50,20
	13.5 > 21	14/15/16	44,80	50,20
	13.5 > 21	19/20/21	44,80	50,20
AL	21.5 > 34	05/06	44,80	50,20
	21.5 > 34	09/10/11	44,80	50,20
	21.5 > 34	14/15/16	44,80	50,20
	21.5 > 34	19/20/21	44,80	50,20

ADJUSTABLE FEET

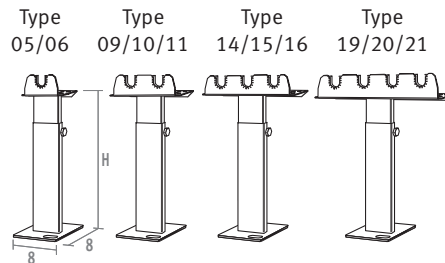

ORDERING CODE

code type colour foot
5205. 000 000 TT. XXX /AS

height adjustable from 13.5 to 21 cm: **AS**
height adjustable from 21.5 to 34 cm: **AL**

For mounting on concrete floor ore for use with raised computer floors

Number of feet for casing length:
from L 060 to 160 cm: 2 feet
from L 180 to 300 cm: 3 feet

MINI-CASING



Standard delivery

- casing in one piece
- colour 133 or 001
- delivered in cardboard packaging

ORDERING CODE

code height length type colour
 CMIN. HHH LLL TT. XXX

L	H 008			H 013			H 023			H 028		
	Type	st. colour	other	Type	st. colour	other	Type	st. colour	other	Type	st. colour	other
060	---	---	---	05	88,70	150,80	06	114,30	194,40	06	144,00	244,80
	09	85,60	145,40	10	96,00	163,20	11	121,70	207,00	11	152,90	260,00
	14	98,30	167,20	15	109,90	187,00	16	137,20	233,40	16	170,30	289,60
	19	103,20	175,60	20	115,30	196,00	21	142,60	242,30	21	177,10	301,20
070	---	---	---	05	90,60	154,00	06	116,20	197,60	06	146,10	248,40
	09	87,70	149,10	10	97,90	166,30	11	123,50	209,90	11	154,80	263,10
	14	100,40	170,60	15	112,00	190,40	16	139,10	236,50	16	173,50	294,80
	19	105,10	178,70	20	117,30	199,40	21	144,60	245,70	21	178,90	304,20
080	---	---	---	05	92,40	157,10	06	118,30	201,10	06	147,90	251,50
	09	89,50	152,10	10	99,80	169,70	11	125,60	213,50	11	156,70	266,40
	14	102,20	173,80	15	113,90	193,60	16	141,20	240,10	16	175,40	298,00
	19	107,10	182,20	20	119,10	202,40	21	146,40	249,00	21	182,10	309,40
090	---	---	---	05	94,50	160,70	06	120,40	204,60	06	150,80	256,40
	09	91,60	155,70	10	101,60	172,70	11	127,60	216,80	11	159,60	271,40
	14	104,20	177,10	15	115,90	197,00	16	143,20	243,40	16	177,10	301,20
	19	109,20	185,50	20	121,20	205,90	21	148,50	252,50	21	183,90	312,70
100	---	---	---	05	96,30	163,70	06	122,00	207,50	06	152,90	260,00
	09	93,50	158,90	10	103,60	176,20	11	129,60	220,30	11	161,70	275,00
	14	106,20	180,50	15	117,60	200,00	16	145,00	246,50	16	180,20	306,30
	19	110,90	188,60	20	123,20	209,40	21	150,50	255,90	21	185,90	315,90
110	---	---	---	05	100,40	170,60	06	127,90	217,50	06	159,60	271,40
	09	97,40	165,70	10	107,90	183,50	11	135,90	230,90	11	169,40	287,90
	14	110,60	188,00	15	122,70	208,60	16	151,90	258,30	16	187,70	319,20
	19	116,20	197,60	20	129,00	219,20	21	158,10	268,80	21	195,80	332,90
120	---	---	---	05	107,10	182,20	06	134,70	229,00	06	167,50	284,70
	09	103,60	176,20	10	115,30	196,00	11	143,20	243,40	11	177,10	301,20
	14	116,80	198,50	15	130,00	220,90	16	159,20	270,70	16	196,60	334,20
	19	123,20	209,40	20	136,80	232,70	21	166,10	282,50	21	204,40	347,60
140	---	---	---	05	116,80	198,50	06	149,40	254,00	06	184,90	314,40
	09	113,30	192,70	10	126,00	214,20	11	158,70	269,60	11	195,80	332,90
	14	127,60	216,80	15	141,60	240,90	16	175,80	298,80	16	215,90	367,00
	19	134,40	228,50	20	149,40	254,00	21	183,30	311,60	21	224,70	382,00
160	---	---	---	05	145,00	246,50	06	183,30	311,60	06	224,70	382,00
	09	139,50	237,30	10	155,20	264,00	11	193,70	329,30	11	237,50	403,70
	14	154,80	263,10	15	171,90	292,20	16	211,90	360,20	16	258,80	440,20
	19	162,50	276,30	20	180,50	306,80	21	220,30	374,50	21	268,70	456,80
180	---	---	---	05	161,70	275,00	06	205,00	348,40	06	250,10	425,30
	09	155,80	264,80	10	172,80	293,90	11	215,90	367,00	11	263,80	448,20
	14	170,90	290,50	15	189,80	322,70	16	234,70	399,00	16	285,20	484,90
	19	180,50	306,80	20	200,60	340,90	21	245,30	417,10	21	297,80	506,30
200	---	---	---	05	180,20	306,30	06	227,20	386,30	06	277,30	471,50
	09	173,50	294,80	10	192,70	327,70	11	240,00	408,00	11	292,00	496,40
	14	189,80	322,70	15	210,70	358,20	16	259,40	440,80	16	314,50	534,50
	19	199,40	339,00	20	221,70	376,70	21	270,30	459,40	21	327,10	556,10
220	---	---	---	05	220,90	375,60	06	273,10	464,30	06	331,00	562,60
	09	210,70	358,20	10	234,00	397,80	11	286,10	486,50	11	346,50	589,10
	14	227,70	387,20	15	253,20	430,30	16	306,60	521,20	16	370,80	630,30
	19	238,80	405,90	20	265,90	451,90	21	319,30	542,70	21	385,40	655,10
240	---	---	---	05	237,50	403,70	06	293,40	498,80	06	355,20	603,90
	09	226,40	384,80	10	251,70	427,90	11	307,40	522,70	11	371,80	632,00
	14	244,40	415,50	15	271,60	461,80	16	329,00	559,30	16	397,30	675,50
	19	256,40	436,00	20	285,20	484,90	21	342,60	582,50	21	412,70	701,50
260	---	---	---	05	252,00	428,40	06	311,90	530,10	06	376,80	640,70
	09	240,30	408,60	10	267,20	454,30	11	327,10	556,10	11	394,20	670,10
	14	259,40	440,80	15	288,10	489,70	16	349,50	594,10	16	421,40	716,30
	19	272,60	463,30	20	302,70	514,60	21	364,00	618,90	21	438,00	744,50

HEAT EXCHANGER - MINI

L	H 008		H 013		H 023 / 028	
	Type	€	Type	€	Type	€
060	---	---	05	59,90	06	139,10
	09	59,90	10	79,90	11	161,10
	14	77,00	15	102,20	16	201,00
	19	93,90	20	125,20	21	215,60
070	---	---	05	71,00	06	161,70
	09	71,00	10	94,50	11	187,40
	14	91,60	15	122,00	16	237,50
	19	113,30	20	151,30	21	257,80
080	---	---	05	76,30	06	172,20
	09	76,30	10	101,60	11	200,70
	14	99,80	15	132,80	16	256,60
	19	124,10	20	165,40	21	280,10
090	---	---	05	80,70	06	181,00
	09	80,70	10	107,60	11	211,20
	14	107,10	15	142,60	16	274,70
	19	133,80	20	178,20	21	300,50
100	---	---	05	90,00	06	199,40
	09	90,00	10	120,40	11	233,80
	14	119,70	15	159,60	16	305,20
	19	151,30	20	201,50	21	337,90
110	---	---	05	95,30	06	210,30
	09	95,30	10	127,20	11	246,20
	14	127,90	15	170,90	16	324,00
	19	161,70	20	215,60	21	360,80
120	---	---	05	100,70	06	220,90
	09	100,70	10	134,40	11	259,40
	14	135,90	15	181,00	16	343,40
	19	172,20	20	229,60	21	383,00
140	---	---	05	110,90	06	241,50
	09	110,90	10	147,90	11	283,90
	14	151,30	15	201,50	16	380,50
	19	208,20	20	277,80	21	460,20
160	---	---	05	133,20	06	286,10
	09	133,20	10	177,70	11	337,20
	14	183,30	15	244,40	16	457,30
	19	251,70	20	335,40	21	552,00
180	---	---	05	144,60	06	308,60
	09	144,60	10	192,70	11	364,40
	14	200,60	15	267,20	16	498,40
	19	274,70	20	365,90	21	601,20
200	---	---	05	155,80	06	331,00
	09	155,80	10	207,80	11	391,50
	14	233,30	15	311,00	16	577,30
	19	297,30	20	396,60	21	650,20
220	---	---	05	182,10	06	383,60
	09	182,10	10	242,40	11	453,70
	14	272,10	15	362,60	16	670,10
	19	348,00	20	463,80	21	757,70
240	---	---	05	194,30	06	407,80
	09	194,30	10	258,80	11	483,50
	14	290,40	15	387,20	16	714,70
	19	373,20	20	497,40	21	811,50
260	---	---	05	207,50	06	434,30
	09	207,50	10	276,40	11	515,00
	14	310,20	15	413,10	16	761,40
	19	398,50	20	531,40	21	865,80

OPPOSITE END CONNECTIONS

Mini height 008



Standard delivery

- Low-H₂O heat exchanger type 09, 14 or 19
- air vent
- drain plug

ORDERING CODE

code	length	type
5004.	000	LLLL TT. /BS9

SAME END CONNECTION

Mini height 013

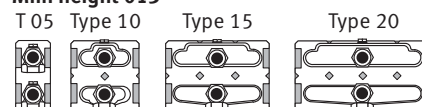

Mini height 023/028

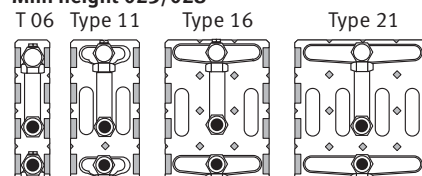

Standard delivery

- Low-H₂O heat exchanger
- air vent
- drain plug

ORDERING CODE

code	length	type
5003.	000	LLL TT. /BS9

DBE OPTION

See DBE renovation set

KNOCKONWOOD - CASING



Standard delivery

- casing in one piece with wooden cover in plywood with high-grade veneer and metal side panels in sandblast grey (001)
- cover plate in stainless steel effect for the side panel at the opposite end from the valve
- delivered in a cardboard box, which can also be used as protection on site after installation

ORDERING CODE

code height length type wood
CKNW. HHH LLL TT. XXX

L	Type	H 030		H 055		H 080	
		cat. 1	cat. 2	cat. 1	cat. 2	cat. 1	cat. 2
060	06	447,10	511,20	484,60	553,70	522,70	596,60
	10/11	453,00	517,80	493,50	562,90	533,80	608,10
	15/16	464,50	530,00	509,10	579,50	554,30	629,70
080	06	483,20	552,20	530,80	606,20	586,50	669,60
	10/11	490,10	559,90	540,30	616,40	600,00	683,60
	15/16	503,70	574,60	558,10	635,10	626,50	712,10
100	06	539,30	615,90	617,30	705,20	705,90	806,20
	10/11	564,10	644,10	629,20	717,90	720,70	821,90
	15/16	579,80	661,70	653,90	745,00	751,90	855,80
120	06	653,20	746,60	733,50	838,10	834,30	953,40
	10/11	663,20	757,70	747,20	852,90	849,80	969,80
	15/16	679,70	775,80	774,00	882,30	882,20	1005,00
140	06	712,40	814,10	817,00	933,60	---	---
	10/11	722,80	825,80	832,10	950,30	---	---
	15/16	741,70	846,80	861,40	982,20	---	---
180	06	747,50	853,30	884,20	1009,80	---	---
	10/11	761,40	868,90	900,90	1028,00	---	---
	15/16	792,00	903,30	933,70	1064,50	---	---
220	06	849,60	969,60	1010,00	1153,30	---	---
	10/11	865,10	987,10	1027,70	1172,90	---	---
	15/16	900,40	1026,90	1065,30	1214,60	---	---

WOOD FINISHES

category 1



Category 2

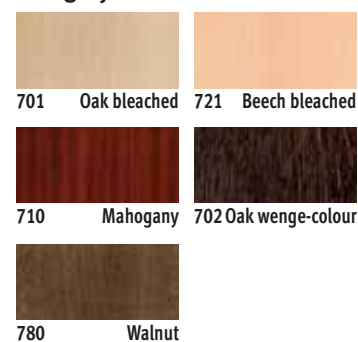

Certification only for
Beech natural,
maple natural, oak
bleached, beech
bleached, oak
wenge-colour

HEAT EXCHANGER - KNOCKONWOOD

L	STANDARD			TWIN				
	Type	H 030	055	080	Type	H 030	055	080
060	---	---	---	---	06	159,00	174,20	180,80
	10	105,70	117,20	125,30	11	182,90	198,20	206,40
	15	130,10	140,50	151,20	16	224,80	238,90	250,00
080	---	---	---	---	06	191,90	207,40	213,90
	10	127,70	139,00	147,20	11	222,60	237,80	246,10
	15	160,80	171,20	182,00	16	280,40	294,60	305,70
100	---	---	---	---	06	219,20	234,50	241,10
	10	146,30	157,70	165,80	11	255,90	271,00	279,40
	15	187,50	197,80	208,60	16	329,10	343,20	354,30
120	---	---	---	---	06	240,80	256,10	262,60
	10	160,40	171,80	179,90	11	281,40	296,40	304,70
	15	209,00	219,20	230,00	16	367,30	381,40	392,30
140	---	---	---	---	06	270,30	290,90	---
	10	184,20	200,60	---	11	315,80	336,10	---
	15	240,50	255,40	---	16	415,30	434,20	---
180	---	---	---	---	06	337,40	357,80	---
	10	228,90	245,30	---	11	396,40	416,60	---
	15	306,20	321,20	---	16	533,30	552,00	---
220	---	---	---	---	06	412,20	432,80	---
	10	278,50	294,90	---	11	485,70	506,10	---
	15	401,40	416,40	---	16	705,10	723,80	---

STANDARD

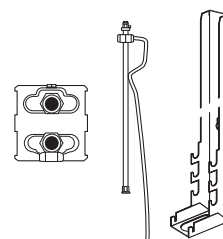

Standard delivery

- Low-H₂O heat exchanger
- wall brackets
- extended air vent
- fixing kit
- drain plug

ORDERING CODE

code	height	length	type
HKNW.	HHH	LLL	TT

TWIN

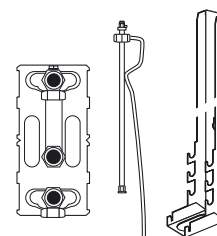

Standard delivery

- Twin Low-H₂O heat exchanger
- wall brackets
- extended air vent
- fixing kit
- drain plug

ORDERING CODE

code	height	length	type
HKNW.	HHH	LLL	TT

DBE OPTION

See DBE renovation set

LINEA PLUS FREESTANDING - CASING



L	Type	H 020		H 035	
		st. colour	other	st. colour	other
050	10/11	77,90	133,10	92,80	158,60
	15/16	90,20	153,80	106,60	181,70
060	10/11	82,80	141,00	100,60	171,50
	15/16	94,90	161,70	114,20	194,80
070	10/11	86,70	147,70	105,60	180,30
	15/16	99,80	169,90	120,30	205,10
080	10/11	94,10	160,20	115,00	195,50
	15/16	107,60	183,30	130,00	221,20
090	10/11	100,20	170,70	125,20	213,00
	15/16	113,80	193,90	140,40	238,70
100	10/11	103,80	176,70	129,50	220,30
	15/16	117,80	200,80	145,10	246,90
110	10/11	108,30	184,50	136,10	231,40
	15/16	122,70	209,30	152,00	258,80
120	10/11	115,30	196,60	143,10	243,90
	15/16	129,90	221,30	159,20	271,20
140	10/11	126,00	214,80	158,80	270,00
	15/16	141,50	241,30	175,80	299,10
160	10/11	155,30	264,40	193,70	329,50
	15/16	171,90	292,50	211,70	360,30
180	10/11	172,80	294,40	216,00	367,80
	15/16	189,70	323,30	234,50	399,30
200	10/11	192,70	328,10	239,90	408,10
	15/16	210,70	358,70	259,40	441,20
220	10/11	234,20	398,40	286,20	486,80
	15/16	253,10	430,60	306,60	521,60
240	10/11	251,60	428,30	307,40	523,10
	15/16	271,40	462,40	328,90	559,80
260	10/11	267,40	455,00	327,00	556,20
	15/16	288,10	490,20	349,30	594,00
280	10/11	282,20	480,00	346,20	589,10
	15/16	303,60	516,30	368,90	628,00

Standard delivery

- partially pre-mounted casing for connection left or right at low level
- colour 133 or 001
- standard adjustable feet in neutral grey
- delivered in a cardboard box, which can also be used as protection on site after installation

ORDERING CODE

code	height	length	type	col.
CLIF.	HHH	LLL	TT.	XXX

HEAT EXCHANGER - LINEA PLUS FREESTANDING

L	STANDARD		TWIN		
	Type	H 020	035	Type	035
050	10	111,80	116,80	11	197,60
	15	133,50	138,20	16	234,40
060	10	117,80	122,70	11	207,80
	15	142,10	146,90	16	249,80
070	10	132,30	137,20	11	234,20
	15	162,10	166,80	16	286,30
080	10	139,50	144,60	11	247,50
	15	172,80	177,70	16	305,40
090	10	145,60	150,50	11	257,90
	15	182,60	187,30	16	323,50
100	10	158,20	163,30	11	280,70
	15	199,70	204,40	16	354,20
110	10	165,10	169,90	11	293,10
	15	210,80	215,60	16	372,90
120	10	191,40	198,80	11	329,40
	15	241,00	248,10	16	416,60
140	10	205,00	212,30	11	354,20
	15	261,60	268,70	16	453,70
160	10	234,50	242,00	11	407,30
	15	304,50	311,50	16	530,60
180	10	249,70	257,00	11	434,60
	15	327,20	334,40	16	571,60
200	10	264,70	272,20	11	461,60
	15	371,00	378,00	16	650,50
220	10	299,40	306,60	11	524,00
	15	422,60	429,70	16	743,40
240	10	334,80	344,60	11	577,10
	15	467,40	476,80	16	812,30
260	10	352,40	362,10	11	608,70
	15	493,30	502,70	16	859,00
280	10	368,90	378,80	11	638,40
	15	518,00	527,40	16	903,50

STANDARD

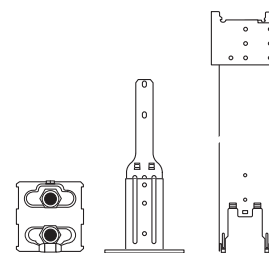

Standard delivery

- heat exchanger
- brackets
- standard feet in neutral grey
- angled air vent
- drain plug

ORDERING CODE

code	height	length	type
HLIF.	HHH	LLL	TT

TWIN

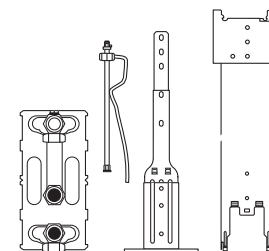

Standard delivery

- Twin Low-H₂O heat exchanger
- brackets
- standard feet in neutral grey
- extended air vent
- drain plug

ORDERING CODE

code	height	length	type
HLIF.	HHH	LLL	TT

TEMPO FREESTANDING - CASING



standard delivery

- kit existing of:
 - grille
 - 2 front panels
 - open side panel for valve connection
 - closed side panel
- colour 101
- compact packaging with cardboard corners and shrink wrapping

ORDERING CODE

code	height	length	type	col.
CTEF.	HHH	LLL	TT.	101

		H 020	H 030	H 040	H 050
L	Type				
040	10/11	51,20	63,40	75,20	88,80
	15/16	55,50	67,80	80,50	94,70
	20/21	60,40	72,60	86,40	101,00
050	10/11	54,80	67,80	80,50	94,90
	15/16	59,20	72,20	85,90	100,80
	20/21	64,20	77,30	91,80	107,30
060	10/11	59,30	74,40	89,00	105,50
	15/16	64,40	79,50	95,00	112,00
	20/21	69,70	84,70	101,40	118,90
070	10/11	65,90	83,10	99,40	117,80
	15/16	71,90	88,80	106,30	125,20
	20/21	77,70	94,70	113,10	132,50
080	10/11	69,10	87,00	104,50	123,90
	15/16	75,50	93,50	111,80	131,80
	20/21	81,80	99,80	119,30	139,50
090	10/11	74,80	94,60	113,90	135,10
	15/16	81,20	100,90	121,30	143,10
	20/21	88,40	108,30	129,60	151,90
100	10/11	80,90	102,70	124,00	147,30
	15/16	87,60	109,40	131,80	155,60
	20/21	95,30	117,20	140,60	165,00
110	10/11	86,30	110,10	133,70	159,00
	15/16	94,60	118,40	142,90	168,80
	20/21	101,90	125,70	151,20	177,70
120	10/11	89,00	113,70	138,10	164,10
	15/16	97,70	122,50	147,70	174,40
	20/21	106,10	130,80	157,00	184,30
140	10/11	103,00	132,80	162,20	193,50
	15/16	112,40	142,10	172,50	204,20
	20/21	121,60	151,30	182,70	215,00
160	10/11	114,10	146,90	179,00	213,30
	15/16	125,40	158,10	191,40	226,10
	20/21	136,90	169,70	203,80	239,00
180	10/11	124,40	161,00	196,90	234,70
	15/16	136,70	173,30	210,10	248,40
	20/21	148,70	185,20	223,10	262,10
200	10/11	138,70	180,20	220,80	263,80
	15/16	152,40	193,70	235,60	278,80
	20/21	165,60	206,90	249,70	293,60
220	10/11	151,90	196,10	239,90	285,40
	15/16	167,40	211,60	256,30	302,50
	20/21	182,50	226,70	272,60	319,20
240	10/11	163,40	211,70	259,60	309,20
	15/16	180,00	228,30	277,10	327,20
	20/21	195,40	243,70	293,60	344,30
260	10/11	172,90	224,20	274,90	327,50
	15/16	191,10	242,20	293,90	347,00
	20/21	208,00	259,20	312,10	365,60
280	10/11	190,80	246,80	302,20	359,40
	15/16	209,90	265,90	322,10	380,00
	20/21	227,20	283,10	340,50	398,90
300	10/11	199,40	258,30	316,70	376,80
	15/16	219,50	278,10	337,60	398,40
	20/21	237,90	296,70	357,00	418,30

HEAT EXCHANGER - TEMPO FREESTANDING

L	STANDARD				TWIN				
	Type	H 020	030	040	050	Type	030	040	050
040	10	102,20	103,20	104,20	105,10	11	178,30	179,10	180,20
	15	119,40	120,40	123,20	125,20	16	208,10	211,20	213,00
	20	136,90	137,90	140,70	143,70	21	217,20	220,00	222,80
050	10	108,90	109,90	111,00	111,80	11	190,90	191,70	192,70
	15	129,60	130,40	133,50	135,10	16	226,50	229,40	231,30
	20	150,00	150,80	153,70	156,80	21	238,10	241,00	243,90
060	10	115,00	115,90	117,00	117,80	11	201,00	201,90	203,00
	15	138,40	139,20	142,10	144,00	16	241,80	245,00	246,90
	20	162,20	163,00	165,90	169,10	21	257,50	260,30	263,20
070	10	129,60	130,40	131,60	132,30	11	227,40	228,40	229,30
	15	158,10	159,20	162,10	163,90	16	278,30	281,40	283,20
	20	188,40	189,30	192,20	195,30	21	299,70	302,50	305,40
080	10	136,80	137,90	138,80	139,50	11	240,70	241,50	242,60
	15	169,10	169,90	172,80	174,60	16	297,40	300,50	302,40
	20	202,70	203,40	206,30	209,30	21	322,00	324,90	327,90
090	10	142,80	143,70	144,80	145,60	11	251,30	252,00	253,10
	15	178,60	179,80	182,60	184,50	16	315,40	318,50	320,30
	20	215,30	216,10	219,00	222,10	21	342,30	345,20	348,10
100	10	155,50	156,50	157,40	158,20	11	273,80	274,80	275,70
	15	195,80	196,80	199,70	201,50	16	346,20	349,10	351,00
	20	238,60	239,50	242,40	245,40	21	379,80	382,70	385,70
110	10	162,20	163,30	164,30	165,10	11	286,30	287,10	288,10
	15	207,00	207,90	210,80	212,60	16	365,00	368,00	369,90
	20	252,70	253,60	256,40	259,60	21	402,60	405,40	408,20
120	10	169,50	170,50	171,60	172,30	11	299,40	300,20	301,20
	15	217,20	218,10	220,90	222,80	16	384,20	387,20	389,20
	20	266,70	267,60	270,60	273,50	21	424,90	427,80	430,60
140	10	200,70	202,10	203,60	205,00	11	344,00	345,20	346,70
	15	255,70	257,30	261,60	264,30	16	441,70	446,40	449,20
	20	333,50	334,80	339,00	343,60	21	522,90	527,30	531,60
160	10	230,20	231,70	233,30	234,50	11	397,10	398,40	399,90
	15	298,50	300,10	304,50	307,20	16	518,50	523,10	525,90
	20	391,00	392,30	396,70	401,20	21	614,90	619,10	623,50
180	10	245,30	246,90	248,40	249,70	11	424,30	425,70	427,20
	15	321,50	323,10	327,20	330,10	16	559,80	564,40	567,10
	20	421,60	422,90	427,20	431,90	21	664,00	668,30	672,60
200	10	260,50	262,00	263,60	264,70	11	451,50	452,80	454,30
	15	365,20	366,70	371,00	373,80	16	638,60	643,20	646,00
	20	452,20	453,60	457,90	462,50	21	713,00	717,30	721,60
220	10	294,90	296,40	298,10	299,40	11	513,80	515,00	516,50
	15	416,60	418,30	422,60	425,40	16	731,40	736,10	738,80
	20	519,50	520,80	525,20	529,70	21	820,40	824,70	829,10
240	10	329,00	331,00	333,10	334,80	11	563,50	565,20	567,20
	15	459,40	461,50	467,40	471,00	16	796,40	802,60	806,30
	20	571,50	573,30	579,00	585,10	21	895,20	901,00	906,80
260	10	346,60	348,70	350,60	352,40	11	595,00	596,80	598,90
	15	485,40	487,50	493,30	497,00	16	842,90	849,10	852,80
	20	605,60	607,20	613,10	619,10	21	949,50	955,30	961,00
280	10	363,30	365,30	367,40	368,90	11	624,80	626,40	628,40
	15	510,10	512,20	518,00	521,60	16	887,60	893,70	897,40
	20	639,30	641,00	646,70	652,90	21	1003,30	1009,20	1014,80
300	10	379,70	381,70	383,80	385,40	11	654,60	656,30	658,40
	15	534,60	536,60	542,30	546,10	16	931,20	937,40	941,20
	20	672,30	674,10	679,90	685,90	21	1056,20	1062,10	1067,70

STANDARD

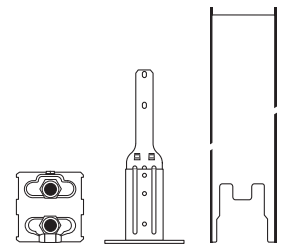

Standard delivery

- heat exchanger
- brackets
- standard feet in neutral grey
- angled air vent
- drain plug

ORDERING CODE

code	height	length	type
HTEF.	HHH	LLL	TT

TWIN

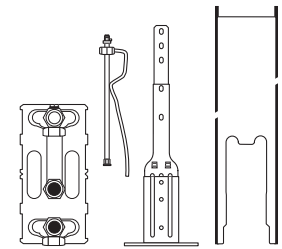

Standard delivery

- Twin Low-H₂O heat exchanger
- brackets
- standard feet in neutral grey
- extended air vent
- drain plug

ORDERING CODE

code	height	length	type
HTEF.	HHH	LLL	TT

MINI CANAL - COMPLETE UNIT WITHOUT GRILLE



Standard delivery

- Pre-assembled, dark grey lacquered Mini Canal with:
- Low-H₂O heat exchanger
 - fixing straps
 - air vent(s) 1/8" and drain plug(s) 1/2"
 - anodised frame or cover frame

Grille dimensions = duct Dimensions - 1.2 cm

L	B	H 009	H 011	H 014	H 019
110		279,40	283,10	307,90	---
		283,80	287,00	---	---
		308,20	314,10	352,20	368,00
		348,20	354,10	402,90	418,50
		389,20	395,60	455,70	472,10
130		316,50	321,00	348,50	---
		322,10	326,00	---	---
		348,70	355,50	398,50	417,40
		395,50	402,90	458,60	478,00
		443,40	450,70	520,10	539,90
150		339,90	344,80	375,10	---
		346,40	351,30	---	---
		375,60	383,60	431,40	453,40
		429,70	438,10	500,00	522,40
		501,30	509,00	592,40	615,20
170		392,00	397,70	432,80	---
		400,40	405,30	---	---
		433,00	442,50	498,50	523,80
		499,50	508,40	583,30	608,60
		584,00	593,10	692,90	718,20
190		415,90	422,80	461,30	---
		425,90	431,90	---	---
		461,50	471,20	533,00	560,70
		535,30	544,80	627,10	655,30
		627,20	637,50	746,20	774,90
210		452,30	459,80	501,70	---
		463,90	470,10	---	---
		501,50	512,50	579,50	610,60
		600,00	611,10	705,80	737,90
		682,30	693,90	812,60	844,50
230		490,80	498,80	545,80	---
		506,30	512,40	---	---
		546,20	557,70	634,50	669,10
		658,50	670,80	780,70	815,20
		755,40	767,70	905,40	940,50
250		516,60	525,70	575,90	---
		533,90	541,20	---	---
		575,90	588,60	671,50	708,30
		696,90	710,00	827,70	865,10
		802,10	815,30	963,00	1000,90
270		542,00	552,20	605,60	---
		561,20	569,20	---	---
		605,10	619,40	707,50	747,70
		734,90	748,40	874,70	915,00
		847,20	861,40	1019,60	1060,40
290		587,10	597,20	654,60	---
		605,90	614,10	---	---
		654,60	669,40	762,90	806,30
		791,20	806,70	940,10	984,30
		912,70	928,30	1096,10	1141,10
310		614,60	625,60	686,20	---
		635,00	643,90	---	---
		686,00	701,90	798,70	845,10
		834,00	850,50	985,40	1032,30
		968,30	984,90	1152,30	1199,90
330		642,80	655,10	718,70	---
		665,30	674,90	---	---
		718,30	735,20	835,00	884,10
		873,20	890,40	1035,00	1085,20
		1028,30	1045,80	1211,50	1262,20
370		709,50	723,20	793,60	---
		735,40	746,00	---	---
		793,20	812,10	921,10	977,00
		965,50	985,20	1142,60	1199,20
		1140,10	1160,00	1340,10	1397,00

ORDERING CODE WITH FRAME



code height length width col.
 MICL. HHH LLL BB XXX
 natural aluminium: **FNA**
 alu black: **FBL**
 alu dark brown: **FDB**
 alu brass: **FBR**
 lacquered: **FNC/XXX**

To ensure perfect adherence of the lacquer coating, an extremely wear-resistant and UV-resistant polyester lacquer coating of the highest quality is used. Only in glossy (code 2..)

ORDERING CODE WITH COVER FRAME



code height length width col.
 MICZ. HHH LLL BB XXX
 natural aluminium: **FNA**
 alu black: **FBL**
 alu dark brown: **FDB**
 alu brass: **FBR**
 lacquered: **FNC/XXX**

The cover frame is designed to provide a perfect finish with renovations or wooden floors.

MINI CANAL DBE - COMPLETE UNIT WITHOUT GRILLE

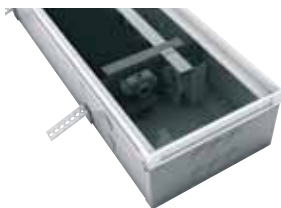

Building in-opening:
 Height H + 1 cm
 Length L + 0.5 cm
 Width B + 0.5 cm

Standard delivery

- Pre-assembled, dark grey lacquered Mini Canal DBE with:
- Low-H₂O heat exchanger
 - fixing straps
 - air vent(s) 1/8" and drain plug(s) 1/2"
 - anodised frame or cover frame

ORDERING CODE WITH FRAME



code height length width col.
 MDCL. HHH LLL BB XXX

- natural aluminium: **FNA**
- alu black: **FBL**
- alu dark brown: **FDB**
- alu brass: **FBR**
- lacquered: **FNC/XXX**

ORDERING CODE WITH COVER FRAME

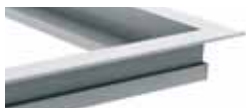

code height length width col.
 MDCZ. HHH LLL BB XXX

- natural aluminium: **FNA**
- alu black: **FBL**
- alu dark brown: **FDB**
- alu brass: **FBR**
- lacquered: **FNC/XXX**

To ensure perfect adherence of the lacquer coating, an extremely wear-resistant and UV-resistant polyester lacquer coating of the highest quality is used. Only in glossy (code 2..)

Grille dimensions = duct dimensions - 1.2 cm

L	B	H 014
110	—	566,50
		609,80
		655,20
130	—	606,20
		657,60
		710,40
150	—	714,80
		773,30
		852,80
170	—	852,70
		924,90
		1019,10
190	—	882,10
		962,60
		1065,10
210	—	1002,30
		1110,40
		1202,00
230	—	1049,40
		1174,50
		1281,70
250	—	1161,50
		1295,20
		1411,40
270	—	1192,30
		1335,40
		1459,90
290	—	1320,20
		1471,90
		1605,90
310	—	1431,20
		1591,10
		1734,30

ORDERING CODE

code length width grille
 GRIL. LLL.L BB.B /XXX

Grille codes see p. 374

GRILLES - MINI CANAL DBE

L	B	DMN DON DBN	RMN	RON RBN	DMV DOV DBV	RMV	ROV RBV	RNA DNA	DBL DDB DBR	RBL RDB RBR	SNA	SBL SDB SBR	ANA	RSS	SNC/XXX	DNC/XXX
108.8		142,53	65,17	81,49	196,93	114,78	131,21	165,27	175,28	175,28	128,82	155,80	248,72	572,94	161,79	211,51
		160,26	71,48	91,72	236,64	124,36	157,76	224,02	237,18	237,18	161,79	197,80	307,14	712,20	204,11	286,91
		177,78	78,23	101,73	275,92	143,94	183,98	241,54	255,90	255,90	195,19	240,77	365,02	932,96	247,96	308,88
128.8		168,73	77,15	96,47	233,13	135,88	155,33	195,65	207,50	207,50	152,50	184,44	294,44	678,26	191,53	250,39
		189,72	84,62	108,58	280,14	147,22	186,76	265,20	280,78	280,78	191,53	234,16	363,60	843,12	241,63	339,65
		210,46	92,61	120,43	326,64	170,40	217,80	285,94	302,94	302,94	231,07	285,03	432,12	1104,46	293,54	365,66
148.8		194,93	89,13	111,45	269,33	156,98	179,45	226,03	239,72	239,72	176,18	213,08	340,16	783,58	221,27	289,27
		219,18	97,76	125,44	323,64	170,08	215,76	306,38	324,38	324,38	221,27	270,52	420,06	974,04	279,15	392,39
		243,14	106,99	139,13	377,36	196,86	251,62	330,34	349,98	349,98	266,95	329,29	499,22	1275,96	339,12	422,44
168.8		221,13	101,11	126,43	305,53	178,08	203,57	256,41	271,94	271,94	199,86	241,72	385,88	888,90	251,01	328,15
		248,64	110,90	142,30	367,14	192,94	244,76	347,56	367,98	367,98	251,01	306,88	476,52	1104,96	316,67	445,13
		275,82	121,37	157,83	428,08	223,32	285,44	374,74	397,02	397,02	302,83	373,55	566,32	1447,46	384,70	479,22
188.8		247,33	113,09	141,41	341,73	199,18	227,69	286,79	304,16	304,16	223,54	270,36	431,60	994,22	280,75	367,03
		278,10	124,04	159,16	410,64	215,80	273,76	388,74	411,58	411,58	280,75	343,24	532,98	1235,88	354,19	497,87
		308,50	135,75	176,53	478,80	249,78	319,26	419,14	444,06	444,06	338,71	417,81	633,42	1618,96	430,28	536,00
208.8		273,53	125,07	156,39	377,93	220,28	251,81	317,17	336,38	336,38	247,22	299,00	477,32	1099,54	310,49	405,91
		307,56	137,18	176,02	454,14	238,66	302,76	429,92	455,18	455,18	310,49	379,60	589,44	1366,80	391,71	550,61
		341,18	150,13	195,23	529,52	276,24	353,08	463,54	491,10	491,10	374,59	462,07	700,52	1790,46	475,86	592,78
228.8		299,73	137,05	171,37	414,13	241,38	275,93	347,55	368,60	368,60	270,90	327,64	523,04	1204,86	340,23	444,79
		337,02	150,32	192,88	497,64	261,52	331,76	471,10	498,78	498,78	340,23	415,96	645,90	1497,72	429,23	603,35
		373,86	164,51	213,93	580,24	302,70	386,90	507,94	538,14	538,14	410,47	506,33	767,62	1961,96	521,44	649,56
248.8		325,93	149,03	186,35	450,33	262,48	300,05	377,93	400,82	400,82	294,58	356,28	568,76	1310,18	369,97	483,67
		366,48	163,46	209,74	541,14	284,38	360,76	512,28	542,38	542,38	369,97	452,32	702,36	1628,64	466,75	656,09
		406,54	178,89	232,63	630,96	329,16	420,72	552,34	585,18	585,18	446,35	550,59	834,72	2133,46	567,02	706,34
268.8		352,13	161,01	201,33	486,53	283,58	324,17	408,31	433,04	433,04	318,26	384,92	614,48	1415,50	399,71	522,55
		395,94	176,60	226,60	584,64	307,24	389,76	553,46	585,98	585,98	399,71	488,68	758,82	1759,56	504,27	708,83
		439,22	193,27	251,33	681,68	355,62	454,54	596,74	632,22	632,22	482,23	594,85	901,82	2304,96	612,60	763,12
288.8		378,33	172,99	216,31	522,73	304,68	348,29	438,69	465,26	465,26	341,94	413,56	660,20	1520,82	429,45	561,43
		425,40	189,74	243,46	628,14	330,10	418,76	594,64	629,58	629,58	429,45	525,04	815,28	1890,48	541,79	761,57
		471,90	207,65	270,03	732,40	382,08	488,36	641,14	679,26	679,26	518,11	639,11	968,92	2476,46	658,18	819,90
308.8		404,53	184,97	231,29	558,93	325,78	372,41	469,07	497,48	497,48	365,62	442,20	705,92	1626,14	459,19	600,31
		454,86	202,88	260,32	671,64	352,96	447,76	635,82	673,18	673,18	459,19	561,40	871,74	2021,40	579,31	814,31
		504,58	222,03	288,73	783,12	408,54	522,18	685,54	726,30	726,30	553,99	683,37	1036,02	2647,96	703,76	876,68

CANAL COMPACT - COMPLETE UNIT WITHOUT GRILLE



Building in-opening:
 Height H + 2 cm
 Length L + 2 cm
 Width B + 2 cm

R 1.5 R 4.0

H	L	B	€	H	L	B	€
036	178		803,50	052	189		949,30
	198		882,90		209		1041,20
	218		983,40		229		1154,10
	238		1091,70		249		1274,70
	258		1173,00		269		1368,50
					289		1463,50
					309		1557,30
					329		1650,90

Standard delivery

- complete pre-assembled waterproof polyester duct with integrated anodized aluminium frame
- integrated frame
- FNA: natural aluminium
- FBL: alu black
- Low-H₂O heat exchanger type 15
- straight air vent and drain plug
- feet and brackets
- separation wall in dark grey expanded polystyrene foam
- cover plate from fibreboard

ORDERING CODE R 1.5

code height length width colour
 CC15. HHH LLL BB XXX
 natural aluminium: **FNA**
 alu black: **FBL**

ORDERING CODE R 4.0

code height length width colour
 CC40. HHH LLL BB XXX
 natural aluminium: **FNA**
 alu black: **FBL**

ORDERING CODE

code length width grille
 GRIL. LLL.L BB.B /XXX
 Grille codes see p. 374

GRILLES - CANAL COMPACT

L	B	DMN DON DBN	RMN	RON RBN	DMV DOV DBV	RMV	ROV RBV	RNA DNA	DBL DDB	RBL RDB	SNA	SBL SDB	ANA	RSS	SNC/XXX	DNC/XXX
174.8		257,48	114,84	147,36	380,19	199,80	253,46	359,91	381,06	381,06	259,93	317,79	493,46	1144,24	327,92	460,95
194.8		286,94	127,98	164,22	423,69	222,66	282,46	401,09	424,66	424,66	289,67	354,15	549,92	1275,16	365,44	513,69
214.8		316,40	141,12	181,08	467,19	245,52	311,46	442,27	468,26	468,26	319,41	390,51	606,38	1406,08	402,96	566,43
234.8		345,86	154,26	197,94	510,69	268,38	340,46	483,45	511,86	511,86	349,15	426,87	662,84	1537,00	440,48	619,17
254.8		375,32	167,40	214,80	554,19	291,24	369,46	524,63	555,46	555,46	378,89	463,23	719,30	1667,92	478,00	671,91
274.8		404,78	180,54	231,66	597,69	314,10	398,46	565,81	599,06	599,06	408,63	499,59	775,76	1798,84	515,52	724,65
294.8		434,24	193,68	248,52	641,19	336,96	427,46	606,99	642,66	642,66	438,37	535,95	832,22	1929,76	553,04	777,39
314.8		463,70	206,82	265,38	684,69	359,82	456,46	648,17	686,26	686,26	468,11	572,31	888,68	2060,68	590,56	830,13

Canal Compact R 1.5

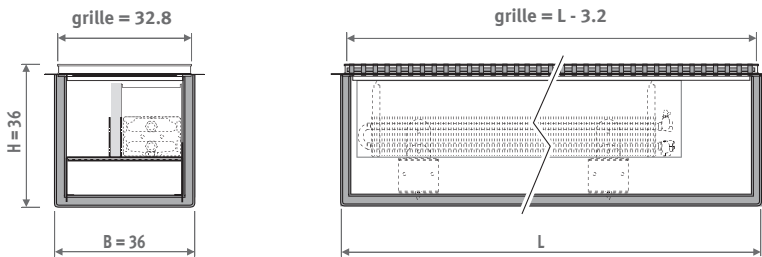

Canal Compact R 4.0

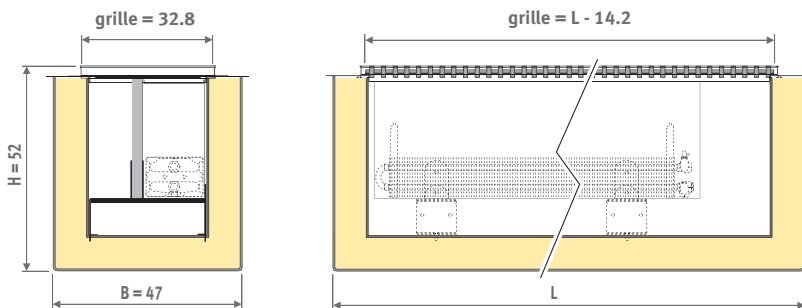

CANAL PLUS - COMPLETE UNIT WITHOUT GRILLE



Building in-opening:
Height H + 2 cm
Length L + 2 cm
Width B + 2 cm

standard delivery

- complete pre-assembled waterproof polyester duct with integrated anodized aluminium frame
- integrated frame
FNA: natural aluminium
FBL: alu black
- Low-H₂O heat exchanger
- straight air vent and drain plug
- feet and brackets
- separation wall in dark grey expanded polystyrene foam
- cover plate from fibreboard

ORDERING CODE

	code	height	length	width	colour
CP25.	HHH	LLL	BB	/XXX	
CP30.	HHH	LLL	BB	/XXX	
CP40.	HHH	LLL	BB	/XXX	

R 2.5				R 3.0				R 4.0			
H	L	B	€	H	L	B	€	H	L	B	€
068	121		574,10	069	123		612,30	072	129		694,90
			632,80				672,70				758,40
			718,20				761,70				855,20
131			613,70	133			654,60	139			742,20
			678,30				720,80				811,50
			769,50				816,20				915,20
141			654,70	143			697,90	149			790,30
			723,20				768,60				864,40
			822,20				871,50				976,30
161			734,10	163			782,70	169			884,80
			812,10				862,90				968,70
			945,30				1000,80				1116,40
181			830,00	183			884,00	189			996,00
			923,90				980,20				1096,10
			1078,70				1140,10				1266,90
201			911,10	203			970,20	209			1092,00
			1015,00				1076,80				1203,10
			1184,10				1251,70				1389,50
221			992,60	223			1056,90	229			1188,50
			1127,90				1195,00				1331,40
			1290,80				1364,20				1513,10
241			1093,10	243			1162,60	249			1304,00
			1247,70				1320,40				1466,90
			1432,90				1512,30				1672,20
261			1175,90	263			1250,70	261			1402,00
			1341,30				1419,50				1576,20
			1542,20				1627,60				1798,70
281			1285,40	283			1365,40	289			1526,40
			1461,70				1545,20				1711,90
			1677,30				1768,60				1950,80
301			1368,50	303			1453,60	309			1624,60
			1555,40				1644,40				1821,30
			1786,80				1884,20				2077,30
321			1450,80	323			1541,20	329			1721,80
			1648,30				1742,70				1929,60
			1894,80				1998,20				2202,50

ORDERING CODE

code length width grille
GRIL. LLL.L BB.B /XXX

Grille codes see p. 374

GRILLES - CANAL PLUS

L	B	DMN	RON	DMV	ROV	RNA	DBL	RBL	SBL	SNA	ANA	RSS	SNC/XXX	DNC/XXX		
		DON	RBN	DOV	RBV	DNA	DBB	RDB	SDB							
		DBN	RMN	DBV	RMV	DNA	DBB	RDB	SDB							
114.8		157,28	70,37	89,89	216,17	113,77	144,19	226,27	239,70	239,70	152,45	187,01	292,51	670,32	192,86	289,64
		169,10	75,42	96,78	249,69	131,22	166,46	236,37	250,26	250,26	170,71	208,71	324,08	751,48	215,36	302,73
		202,39	90,58	115,60	316,85	167,15	211,12	264,61	280,00	280,00	223,06	275,86	416,95	989,92	284,13	338,32
124.8		170,98	76,50	97,72	235,00	123,68	156,75	245,98	260,58	260,58	165,73	203,30	317,99	728,71	209,66	314,87
		183,83	81,99	105,21	271,44	142,65	180,96	256,96	272,06	272,06	185,58	226,89	352,31	816,94	234,12	329,10
		220,02	98,47	125,67	344,45	181,71	229,51	287,66	304,39	304,39	242,49	299,89	453,27	1076,15	308,88	367,79
134.8		184,68	82,63	105,55	253,83	133,59	169,31	265,69	281,46	281,46	179,01	219,59	343,47	787,10	226,46	340,10
		198,56	88,56	113,64	293,19	154,08	195,46	277,55	293,86	293,86	200,45	245,07	380,54	882,40	252,88	355,47
		237,65	106,36	135,74	372,05	196,27	247,90	310,71	328,78	328,78	261,92	323,92	489,59	1162,38	333,63	397,26
154.8		212,08	94,89	121,21	291,49	153,41	194,43	305,11	323,22	323,22	205,57	252,17	394,43	903,88	260,06	390,56
		228,02	101,70	130,50	336,69	176,94	224,46	318,73	337,46	337,46	230,19	281,43	437,00	1013,32	290,40	408,21
		272,91	122,14	155,88	427,25	225,39	284,68	356,81	377,56	377,56	300,78	371,98	562,23	1334,84	383,13	456,20
174.8		239,48	107,15	136,87	329,15	173,23	219,55	344,53	364,98	364,98	232,13	284,75	445,39	1020,66	293,66	441,02
		257,48	114,84	147,36	380,19	199,80	253,46	359,91	381,06	381,06	259,93	317,79	493,46	1144,24	327,92	460,95
		308,17	137,92	176,02	482,45	254,51	321,46	402,91	426,34	426,34	339,64	420,04	634,87	1507,30	432,63	515,14
194.8		266,88	119,41	152,53	366,81	193,05	244,67	383,95	406,74	406,74	258,69	317,33	496,35	1137,44	327,26	491,48
		286,94	127,98	164,22	423,69	222,66	282,46	401,09	424,66	424,66	289,67	354,15	549,92	1275,16	365,44	513,69
		343,43	153,70	196,16	537,65	283,63	358,24	449,01	475,12	475,12	378,50	468,10	707,51	1679,76	482,13	574,08
214.8		294,28	131,67	168,19	404,47	212,87	269,79	423,37	448,50	448,50	285,25	349,91	547,31	1254,22	360,86	541,94
		316,40	141,12	181,08	467,19	245,52	311,46	442,27	468,26	468,26	319,41	390,51	606,38	1406,08	402,96	566,43
		378,69	169,48	216,30	592,85	312,75	395,02	495,11	523,90	523,90	417,36	516,16	780,15	1852,22	531,63	633,02
234.8		321,68	143,93	183,85	442,13	232,69	294,91	462,79	490,26	490,26	311,81	382,49	598,27	1371,00	394,46	592,40
		345,86	154,26	197,94	510,69	268,38	340,46	483,45	511,86	511,86	349,15	426,87	662,84	1537,00	440,48	619,17
		413,95	185,26	236,44	648,05	341,87	431,80	541,21	572,68	572,68	456,22	564,22	852,79	2024,68	581,13	691,96
254.8		349,08	156,19	199,51	479,79	252,51	320,03	502,21	532,02	532,02	338,37	415,07	649,23	1487,78	428,06	642,86
		375,32	167,40	214,80	554,19	291,24	369,46	524,63	555,46	555,46	378,89	463,23	719,30	1667,92	478,00	671,91
		449,21	201,04	256,58	703,25	370,99	468,58	587,31	621,46	621,46	495,08	612,28	925,43	2197,14	630,63	750,90
274.8		376,48	168,45	215,17	517,45	272,33	345,15	541,63	573,78	573,78	364,93	447,65	700,19	1604,56	461,66	693,32
		404,78	180,54	231,66	597,69	314,10	398,46	565,81	599,06	599,06	408,63	499,59	775,76	1798,84	515,52	724,65
		484,47	216,82	276,72	758,45	400,11	505,36	633,41	670,24	670,24	533,94	660,34	998,07	2369,60	680,13	809,84
294.8		403,88	180,71	230,83	555,11	292,15	370,27	581,05	615,54	615,54	391,49	480,23	751,15	1721,34	495,26	743,78
		434,24	193,68	248,52	641,19	336,96	427,46	606,99	642,66	642,66	438,37	535,95	832,22	1929,76	553,04	777,39
		519,73	232,60	296,86	813,65	429,23	542,14	679,51	719,02	719,02	572,80	708,40	1070,71	2542,06	729,63	868,78
314.8		431,28	192,97	246,49	592,77	311,97	395,39	620,47	657,30	657,30	418,05	512,81	802,11	1838,12	528,86	794,24
		463,70	206,82	265,38	684,69	359,82	456,46	648,17	686,26	686,26	468,11	572,31	888,68	2060,68	590,56	830,13
		554,99	248,38	317,00	868,85	458,35	578,92	725,61	767,80	767,80	611,66	756,46	1143,35	2714,52	779,13	927,72

Canal Plus R 2.5

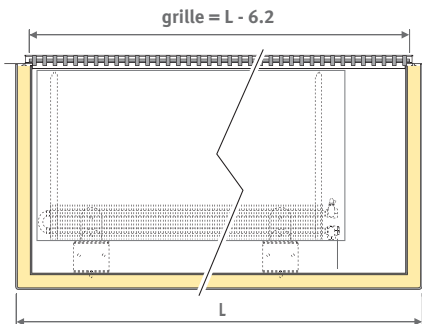
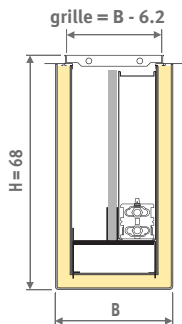

Canal Plus R 3.0

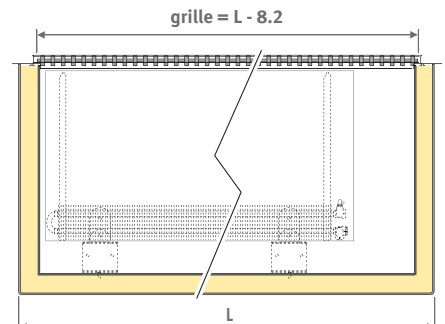
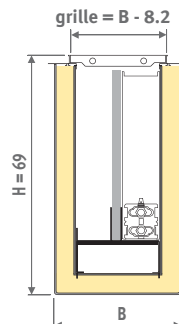

Canal Plus R 4.0

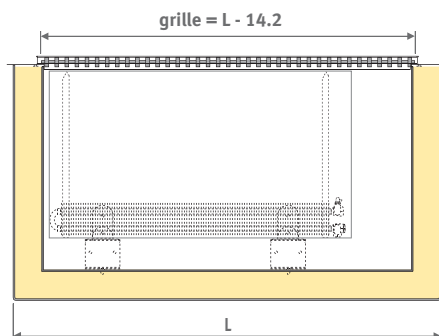
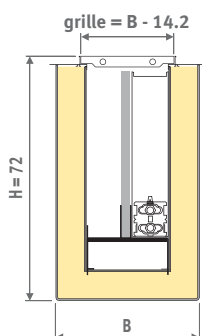

SEPARATE GRILLES

ORDERING CODE

code length width grille
 GRIL. LLL.L BB.B /XXX
 |
 Grille codes

€/METRE

B	DMN DON DBN	RMN	RON RBN	DMV DOV DBV	RMV	ROV RBV	RNA DNA	DBL DDB DBR	RBL RDB RBR	SNA	SBL SDB SBR	RSS	SNC/XXX	DNC/XXX
12.8	107,30	50,70	61,30	141,00	76,30	93,90	127,20	134,70	134,70	72,30	84,60	415,80	89,00	162,50
16.8	115,00	53,30	65,70	155,50	84,30	103,60	135,10	143,50	143,50	87,70	104,40	462,40	108,80	173,30
24.8	131,00	59,90	74,90	181,00	105,50	120,60	151,90	161,10	161,10	118,40	143,20	526,60	148,70	194,40
28.8	137,00	61,30	78,30	188,30	99,10	125,60	197,10	208,80	208,80	132,80	162,90	583,90	168,00	252,30
32.8	147,30	65,70	84,30	217,50	114,30	145,00	205,90	218,00	218,00	148,70	181,80	654,60	187,60	263,70
36.8	155,10	68,10	88,70	235,20	122,70	156,70	214,30	226,80	226,80	164,30	201,50	696,50	208,10	274,20
40.8	163,40	71,90	93,50	253,60	132,30	169,10	222,00	235,20	235,20	179,40	221,30	857,50	227,90	283,90
44.8	176,30	78,90	100,70	276,00	145,60	183,90	230,50	243,90	243,90	194,30	240,30	862,30	247,50	294,70
48.8	190,90	85,20	109,20	288,30	151,90	192,20	275,90	292,50	292,50	210,30	259,20	933,00	268,10	353,10
52.8	207,00	91,90	118,30	324,00	170,30	215,90	284,20	301,40	301,40	225,80	279,50	1009,80	287,80	363,80
56.8	222,40	99,10	127,20	348,10	183,30	231,90	292,00	309,40	309,40	240,30	299,40	1068,90	307,20	373,60

! Indicate length in cm. Max. 6 m in 1 piece. Length grille = length frame - 1.2 cm.

For all technical information see page 391.

DESIGNO RIGID ALUMINIUM GRILLES



DNA natural coloured **DBL** black **DDB** dark brown **DBR** brass coloured **DNC/XXX** lacquered

RIGID ALUMINIUM GRILLES



SNA natural coloured **SBL** black **SDB** dark brown **SBR** brass coloured **SNC/XXX** lacquered

ROLL-UP ALUMINIUM GRILLES



RNA natural coloured **RBL** black **RDB** dark brown **RBR** brass coloured **RSS** stainless steel

STAINLESS STEEL GRILLE

DESIGNO ROLL-UP WOODEN GRILLES



DMN merbau natural coloured **DMV** merbau varnished **DBN** beech natural coloured **DBV** beech varnished **DON** oak natural coloured **DOV** oak varnished

ROLL-UP WOODEN GRILLES

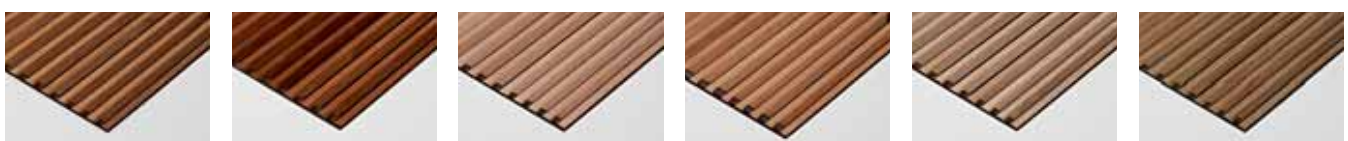

RMN merbau natural coloured **RMV** merbau varnished **RBN** beech natural coloured **RBV** beech varnished **RON** oak natural coloured **ROV** oak varnished

SEPARATE GRILLES

B	€/tile
24.8	302,80
28.8	335,80
32.8	376,30
40.8	493,15



PNC /026
cast aluminium
platinum gray
RAL 9006



PNC /028
cast aluminium
granite grey

PEBBLES

ORDERING CODE

code	length	width	grille
GRIL .	LLL.L	BB.B	PNC

50 cm length tile.
Indicate the total required grille length in the ordering code. (Eg. 205.4 cm, this grille exists of 5 tiles, shortened in production.)

Grille dimensions = frame -1.2 cm.

B	€/m
24.8	207,30
28.8	231,10
32.8	256,10
40.8	304,30
44.8	329,40



ANA
alu. natural colour

ACCORDION

ORDERING CODE

code	length	width	grille
GRIL .	LLL.L	BB.B	ANA

For custom made lengths:
indicate the desired length in cm in the ordering code.
Length up to 1.70 m in one piece.
Longer grilles are delivered in sections.
Other widths on request.

Grille dimensions = frame -1.2 cm.

FRAME / COVER FRAME

B	€/m
14.0	40,50
18.0	40,80
26.0	41,90
30.0	42,30
34.0	42,80
38.0	43,50
42.0	43,50
46.0	44,20
50.0	44,90
54.0	45,30
58.0	45,30

FRAME

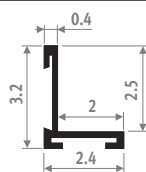

Frame in anodized aluminium.
Length up to 6 metres in one piece.

COVER FRAME

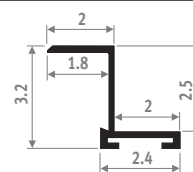

Cover frame in anodized aluminium.
Length up to 6 metres in one piece.
The cover frame allows a perfect finish with renovations or wooden floors.

Mini Canal is available with L-profile or Z-profile frame.
Canal Compact and Canal Plus are only available with L-profile frame.

ORDERING CODE FRAME

code	length	width	colour
FRML .	LLL.L	BB.B	XXX
natural aluminium: FNA			
alu black: FBL			
alu dark brown: FDB			
alu brass: FBR			
lacquered: FNC/XXX			

ORDERING CODE COVER FRAME

code	length	width	colour
FRMZ .	LLL.L	BB.B	XXX
natural aluminium: FNA			
alu black: FBL			
alu dark brown: FDB			
alu brass: FBR			
lacquered: FNC/XXX			

To ensure perfect adherence of the lacquer coating, an extremely wear-resistant and UV-resistant polyester lacquer coating of the highest quality is used. Only in glossy (code 2..)

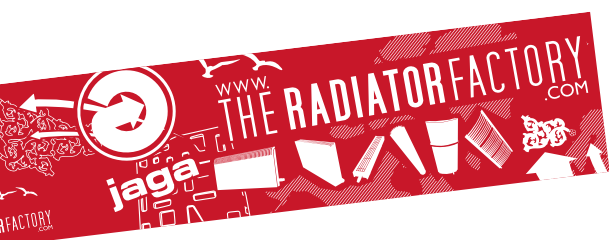

Jaga International
Verbindingslaan z/n
B-3590 Diepenbeek

Tel.: +32 (0)11 29 41 16
Fax: +32 (0)11 29 41 60
export@jaga.be

The information in this price list is correct at the time of printing.
Jaga reserves the right to change product specification at any time in line
with our policy of continuous improvement and innovation.
All prices in Euro, exclude VAT. Prices valid from 1st August 2016.
Replaces all existing price lists.