

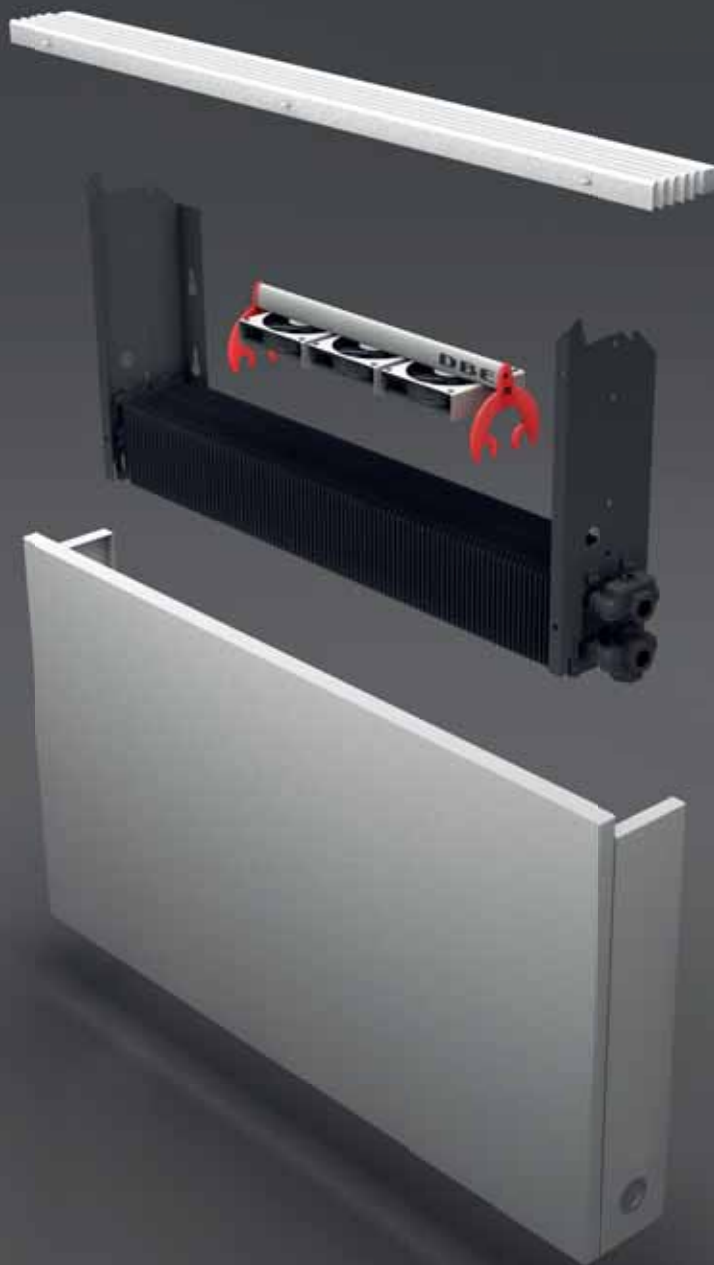

jaga



PARTS & OPTIONS

€ 2016-2017.EX



jaga





PARTS & OPTIONS

FIXINGS

CONFIGURATION

Add ordering codes of the desired fixings to the radiator code.

- All fixings referred to are welded to the radiator. They cannot be changed afterwards. Please check carefully that the required options are ordered correctly. Incorrect orders will not be taken back.

- When ordering a radiator with optional fixings (feet, side or ceiling fixings) the standard wall fixings are not delivered. If you add code 9094.10 (no surcharge), the standard wall fixings will be delivered in addition to the optional fixings.

SANI RONDA / SANI PANEL / SANI LOUVRE

⚠ Fixings will be delivered in the same colour as the radiator.
Chrome only for Sani Ronda.

SIDE FIXING

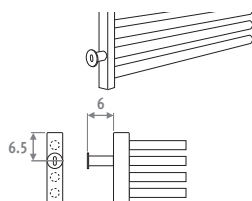

standard colour: 233, 001

CODE	colour	description	€
9085.11	st. colour	left above	24,30
9085.11	other	left above	30,60
9085.11	chrome 009	left above	50,70
9085.12	st. colour	left below	24,30
9085.12	other	left below	30,60
9085.12	chrome 009	left below	50,70
9085.21	st. colour	right above	24,30
9085.21	other	right above	30,60
9085.21	chrome 009	right above	50,70
9085.22	st. colour	right below	24,30
9085.22	other	right below	30,60
9085.22	chrome 009	right below	50,70

FEET

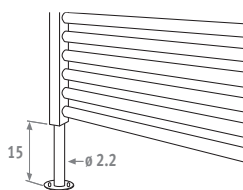

standard colour: 233, 001

CODE	colour	description	€
9083.10	st. colour	left	25,50
9083.10	other	left	30,60
9083.10	chrome 009	left	50,70
9083.20	st. colour	right	25,50
9083.20	other	right	30,60
9083.20	chrome 009	right	50,70

Connection 1-1 (left) or 8-8 (right) are not possible when feet are ordered.

CEILING FIXING

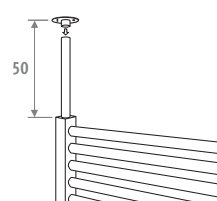

standard colour: 233, 001

CODE	colour	description	€
9082.10	st. colour	left	25,50
9082.10	other	left	30,60
9082.10	chrome 009	left	50,70
9082.20	st. colour	right	25,50
9082.20	other	right	30,60
9082.20	chrome 009	right	50,70

It is 50 cm long and can be shortened as required during installation.

DECO SPACE

⚠ Fixings will be delivered in the same colour as the radiator.

SIDE FIXING

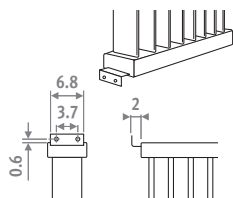

standard colour: 233, 001

CODE	colour	description	€
9095.11	st. colour	left above	25,50
9095.11	other	left above	30,60
9095.12	st. colour	left below	25,50
9095.12	other	left below	30,60
9095.21	st. colour	right above	25,50
9095.21	other	right above	30,60
9095.22	st. colour	right below	25,50
9095.22	other	right below	30,60

When ordering side fixings, a side connection (connection code 2, 3, 6, 7) is not possible.

FEET

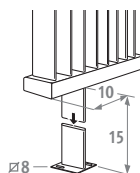

standard colour: 233, 001

CODE	colour	description	€
9093.11	st. colour	left	25,50
9093.11	other	left	30,60
9093.21	st. colour	right	25,50
9093.21	other	right	30,60

CEILING FIXING

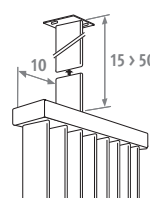

standard colour: 233, 001

CODE	colour	description	€
9092.11	st. colour	links	25,50
9092.11	other	links	30,60
9092.21	st. colour	rechts	25,50
9092.21	other	rechts	30,60

It is 50 cm long and can be shortened as required during installation.

DECO PANEL

⚠ Fixings will be delivered in the same colour as the radiator.

SIDE FIXING

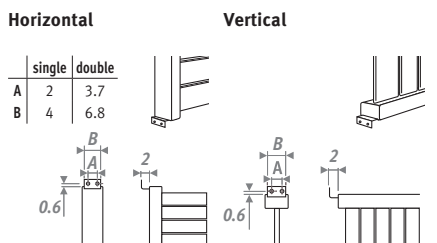

standard colour: 233, 001

CODE	colour	description	€
9095.11	st. colour	left above	25,50
9095.11	other	left above	30,60
9095.12	st. colour	left below	25,50
9095.12	other	left below	30,60
9095.21	st. colour	right above	25,50
9095.21	other	right above	30,60
9095.22	st. colour	right below	25,50
9095.22	other	right below	30,60

When ordering side fixings, a side connection (connection code 2, 3, 6, 7) is not possible.

FEET

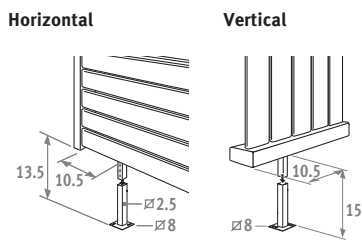

standard colour: 233, 001

CODE	colour	description	€
9093.10	st. colour	left	25,50
9093.10	other	left	30,60
9093.20	st. colour	right	25,50
9093.20	other	right	30,60
9093.30	st. colour	central*	25,50
9093.30	other	central*	30,60

* Only necessary for Deco Panel horizontal double from 220 to 300 cm long.

CEILING FIXING

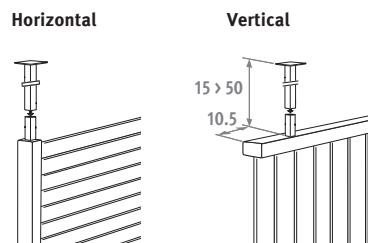

standard colour: 233, 001

CODE	colour	description	€
9092.10	st. colour	left	25,50
9092.10	other	left	30,60
9092.20	st. colour	right	25,50
9092.20	other	right	30,60

It is 50 cm long and can be shortened as required during installation.

⚠ When mounting the radiator at right angles to the wall no feet nor ceiling fixings can be used at the wall side.

PANEL PLUS

⚠ Fixings will be delivered in the same colour as the radiator.

SIDE FIXING

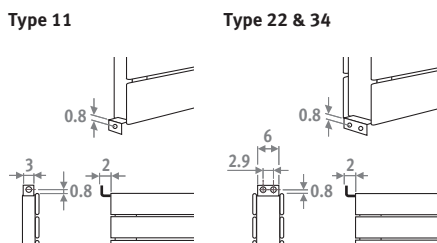

standard colour: 233, 001

CODE	colour	description	€
9095.11	st. colour	left above	25,50
9095.11	other	left above	30,60
9095.12	st. colour	left below	25,50
9095.12	other	left below	30,60
9095.21	st. colour	right above	25,50
9095.21	other	right above	30,60
9095.22	st. colour	right below	25,50
9095.22	other	right below	30,60

⚠ With type 34 (double radiator) the side support will be welded on the front collector.

FEET

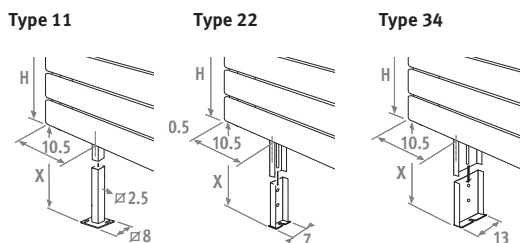

standard colour: 233, 001

CODE	colour	type	advised H Radiator	X (H foot)	€
9093.01075	standard colour	11	6 - 12	7.5	25,50
9093.01075	other	11	6 - 12	7.5	30,60
9093.01100	standard colour	11	18	10 > 13	25,50
9093.01100	other	11	18	10 > 13	30,60
9093.01120	standard colour	11	> 24	12 > 17	25,50
9093.01120	other	11	> 24	12 > 17	30,60
9093.02075	standard colour	22	6 - 12	7.5	25,50
9093.02075	other	22	6 - 12	7.5	30,60
9093.02100	standard colour	22	18	10 > 13	25,50
9093.02100	other	22	18	10 > 13	30,60
9093.02120	standard colour	22	> 24	12 > 17	25,50
9093.02120	other	22	> 24	12 > 17	30,60
9093.03075	standard colour	34	6 - 12	7.5	25,50
9093.03075	other	34	6 - 12	7.5	30,60
9093.03100	standard colour	34	18	10 > 13	25,50
9093.03100	other	34	18	10 > 13	30,60
9093.03120	standard colour	34	> 24	12 > 17	25,50
9093.03120	other	34	> 24	12 > 17	30,60

⚠ The feet will be delivered in the same colour as the radiator.

Number of feet per radiator:
 L 060 up to 200 cm > 2
 L 220 up to 300 cm > 3
 L 320 up to 460 cm > 4

Number of feet per radiator:
 L 060 to 200 cm > 2
 L 220 to 300 cm > 3
 L 320 to 460 cm > 4

ELECTRIC HEATING ELEMENT

ALL TOWEL RADIATORS AND GEO

CONNECTION

- Fit the electric heating element vertically in valve position 1 or 8.
- Fit the pressure relief valve (3 bar) in the air vent socket.
- Do not switch the radiator on before filling it completely with water.
- Fill up the radiator with water when it is fully heated for the first time (not with mixed application).

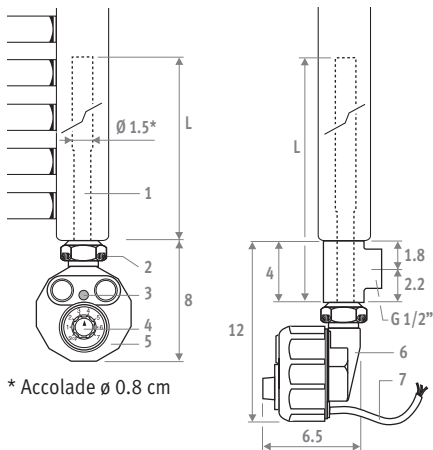

100% ELECTRICAL

1. Electric heating element in stainless steel with case \varnothing 1.5 cm
2. Connection 1/2"
3. Indicator:
 - red: the heating element has reached max. heating.
 - green/red heating: controlled consumption
 - green: desired capacity is reached
 - No indicator: radiator switched off
4. Electronic thermostat
 - position 0: radiator switched off
 - position -: maximum heating
 - frost resistance: turn the thermostat to the 0 position. Turn clockwise until you hear "click" (indicator stays green).
5. Material ABS white
 - Class I: IP 54
 - Class II (not for Accolade): IP 54
6. Electronic control device with double temperature limiter.
7. Connection cable for connection in earthed socket:
 - length 1.2 m
 - 230 V single phase - 50 Hz

MIXED APPLICATION

- Fit the T-piece together with the electrical heating element for connection to the central heating wet system.
- NEVER isolate the radiator from the expansion system, in other words never cut off the return of the radiator.

T-piece for mixed application

CODE	colour	€
TPCE.004.009	chrome	6,90
TPCE.004.XXX	201 to 233	6,90
	301 to 333	6,90

fill in colour code

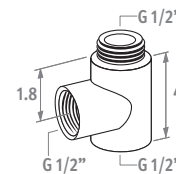

For connection at the side or at the back

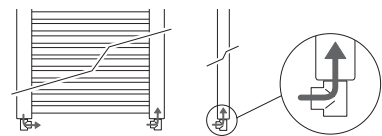

For mixed connection

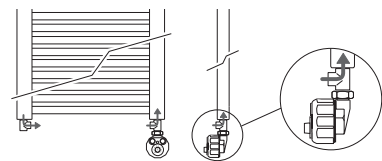

⚠ Which output to select?

Select the electric heating element output no more than 25% above the wet system output at 75/65/20.

CODE	H radiator	TYPE	WATTS	L	€
For GEO					
Class II					
9096.21	150	100% electrical, 2 additional T-pieces have to be ordered for mixed	600	35.5	359,70
9096.23	180	100% electrical, 2 additional T-pieces have to be ordered for mixed	1200	66.0	400,60

For SANI RONDA / SANI PANEL / SANI BOW / SANI BASIC / NAUTICA

Class II					
9096.20	-	100% electrical, additional T-piece has to be ordered for mixed	450	31.5	350,50
9096.21	-	100% electrical, additional T-piece has to be ordered for mixed	600	35.5	359,70
9096.22	-	100% electrical, additional T-piece has to be ordered for mixed	900	51.5	380,60
9096.23	-	100% electrical, additional T-piece has to be ordered for mixed	1200	66.0	400,60
9096.24	-	100% electrical, additional T-piece has to be ordered for mixed	1500	82.0	431,20

For ACCOLADE

Class I					
9096.40	-	100% electrical, additional T-piece has to be ordered for mixed	450	37	298,00
9096.41	-	100% electrical, additional T-piece has to be ordered for mixed	600	47	308,30
9096.42	-	100% electrical, additional T-piece has to be ordered for mixed	900	68	324,60
9096.43	-	100% electrical, additional T-piece has to be ordered for mixed	1200	89	341,00
9096.44	-	100% electrical, additional T-piece has to be ordered for mixed	1500	110	363,70

ELECTRIC ELEMENT ECO COMFORT

Sani Ronda, Nautica, Sani Panel, Sani Louvre, Sani Basic, Sani Bow

CONNECTION

- Fit the electric heating element vertically in valve position 1 or 8.
- Fit the pressure relief valve (3 bar) in the air vent socket.
- Do not switch the radiator on before filling it completely with water.
- Fill up the radiator with water when it is fully heated for the first time (not with mixed application).



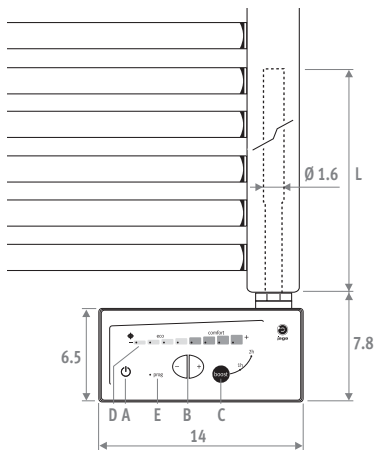

100% Electrical

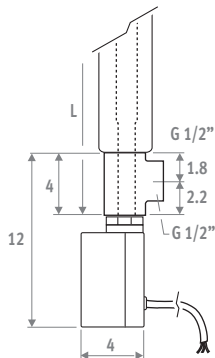

Mixed



TECHNICAL DATA

- Heating element class II   with case in stainless steel \varnothing 1.6 cm
- Power supply heating element: 230 V single phase 50 Hz
- Electronic thermostat: 14 x 7 x 4.8 cm
- Casing: ABS/PC white
- Insulation class IP 54
- Temperature that can be set from +7°C to +30°C ambient temperature
- Length of cycle: 1 or 2 hours
- Connection cable for connection in socket outlet, length 0.50 m. The black wire should NOT be used and must be insulated.

ELECTRIC HEATING ELEMENT WITH BOOST FUNCTION

- A. On/off button.
- B. Temperature setting (+7°C up to +30°C). Measuring of the room temperature by means of an external sensor.
- C. Boost function 1 or 2 hours. Can be interrupted at each time.
- D. Temperature indication by blue indication leds: Anti-freeze protection, Eco, Comfort or Max.
- E. Only for France.

MIXED APPLICATION

- Fit the T-piece together with the electrical heating element for connection to the central heating wet system.
- NEVER isolate the radiator from the expansion system, in other words never cut off the return of the radiator.

T-piece for mixed application

CODE	colour	€
TPCE.004.009	chrome	6,90
TPCE.004.XXX	201 to 233	6,90
	301 to 333	6,90

fill in colour code

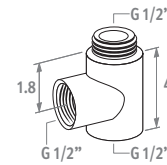

For connection at the side or at the back

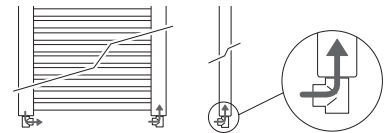

For mixed connection

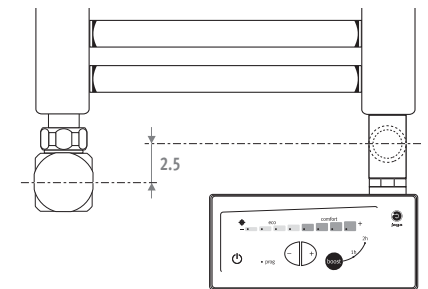
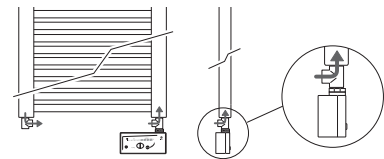

CODE	WATTS	L	€
9096.60	600	55.0	304,40
9096.61	750	60.0	321,10
9096.62	900	69.5	314,10
9096.63	1000	72.0	322,10
9096.64	1250	85.0	322,50
9096.65	1500	96.5	327,00

For mixed application: order 1 or 2 T-pieces.

⚠ Which output to select?

Select the electric heating element output no more than 25% above the wet system output at 75/65/20.



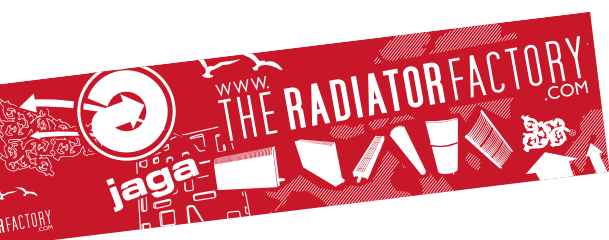

Jaga International
Verbindingslaan z/n
B-3590 Diepenbeek

Tel.: +32 (0)11 29 41 16
Fax: +32 (0)11 29 41 60
export@jaga.be

The information in this price list is correct at the time of printing.
Jaga reserves the right to change product specification at any time in line
with our policy of continuous improvement and innovation.
All prices in Euro, exclude VAT. Prices valid from 1st August 2016.
Replaces all existing price lists.